

# ELECTROMAGNETIC DESIGN OF A RADIO FREQUENCY QUADRUPOLE FOR THE FRONT END TEST STAND AT RAL

A. Kurup, Imperial College London, UK  
A. Letchford, CCLRC/RAL/ISIS, Chilton, Didcot, Oxon, UK

## Abstract

The goal of the RAL front end test stand is to demonstrate cleanly chopped bunches of a 60mA  $H^-$  ion beam at 3MeV. The acceleration of the  $H^-$  ions from 65keV to 3MeV will be done using a radio frequency quadrupole (RFQ) operating at a resonant frequency of 324MHz. The two types of RFQ considered were a 4-vane and a 4-rod. The 4-vane has a higher Q-value but the post-production adjustment is limited. The 4-rod design is easier to manufacture but requires complicated cooling at 324MHz. The results of electromagnetic simulations using CST Microwave Studio are presented for the 4-vane type and 4-rod type RFQ.

## INTRODUCTION

High power proton drivers ( $\sim 4$  MW) that employ charge exchange injection require high efficiency  $H^-$  ion front-ends. RFQs provide simultaneous acceleration and focussing for low energy ions, which results in a high transmission efficiency. The RAL front end test stand is designed to demonstrate the technology needed for the front end of a high power proton driver. The RFQ is required to accelerate a 60mA  $H^-$  ion beam, with input emittance of  $0.25 \pi$  mm mrad, from 65 keV to 3 MeV.

Particle tracking simulations were performed, using code developed by A. Letchford [3], that gave a transmission efficiency of 95%. From these studies the radius of the rods and the distance between rods were determined. These parameters were also used for the vane tip radius and distance between vane tips and were fixed in all the simulations.

The frequency choice of 324 MHz favours the 4-vane design from the point of the Q-value but post-manufacturing adjustment difficulties and the influence of dipole modes may lead to the 4-rod design being favoured. The aim of these simulations was to create a design that maximised the Q-value without creating non-uniform heating or electric field distributions, which would affect the beam transport. Cold-models of both the 4-rod and 4-vane designs would then be made to compare with the simulations.

## ELECTROMAGNETIC SIMULATION METHOD

CST Microwave Studio was used to calculate the eigenmodes of the RFQ and the Q-value of each mode. The simulations were done by taking the engineering model (drawn

using Autodesk Inventor) and removing the features that would not significantly affect the electromagnetic simulations. The inside volume of the model was then imported into Microwave Studio. Using Inventor to draw the model eliminates the need to maintain two separate versions in two different environments and ensures that the model used for the simulations is realistic and can be built. Hiding the engineering features allows the meshing to be done on a simplified shape therefore reducing the complexity of the calculation and simplifying the application of boundary conditions. Once the final design has been obtained the engineering features can then easily be reapplied.

Microwave Studio uses the Finite Integration Method and for these simulations, the automatic hexahedral mesher was used with the Perfect Boundary Approximation (PBA) [1] option. Using the PBA option allows a coarse mesh to describe a finer geometry. The Jacobi-Davidson method eigenmode solver was then used to determine the resonant frequencies.

## SIMULATIONS OF A 4-VANE TYPE RFQ

The simulation of the 4-vane RFQ included tuning holes, vacuum ports, coupling ports and vane cutaways. Fig. 1 shows the cross-section of the CAD model and the inside volume imported into Microwave Studio. The diameter marked on Fig. 1 was varied, whilst keeping the distance between vanes fixed, until a resonant frequency of 324 MHz was obtained.

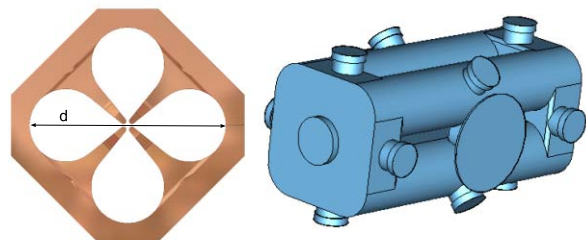

Figure 1: Cross section of the 4-vane Model (left) and the inside volume imported into Microwave Studio. The diameter,  $d$ , was varied to obtain a resonant frequency of 324 MHz.

Fig. 2 and Fig. 3 show the variation of the frequency and Q-value, respectively, with the number of mesh lines per wavelength used in the simulation.

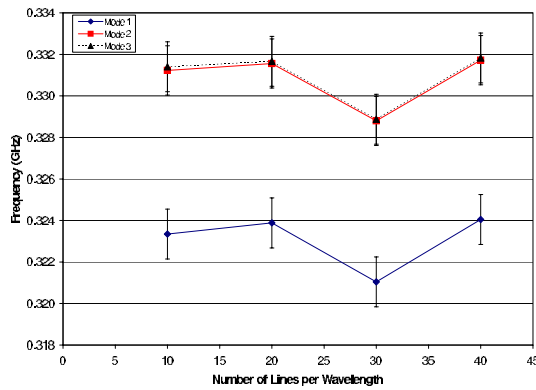

Figure 2: Plot showing the variation of the resonant frequency of the first three modes with the number of lines per wavelength used to mesh the geometry. Mode 1 is the quadrupole mode and Mode 2 and 3 are the adjacent dipole modes.

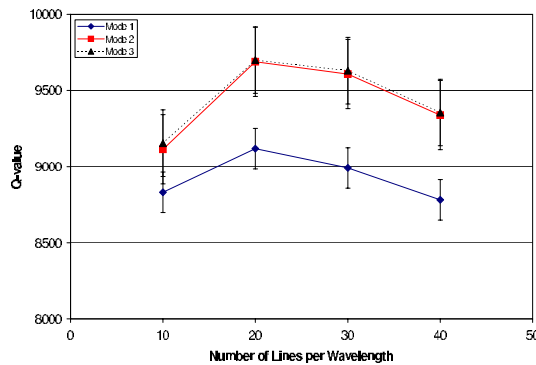

Figure 3: Plot showing the variation of the Q-value of the first three modes with the number of lines per wavelength used to mesh the geometry.

## TUNING SIMULATIONS OF THE 4-VANE TYPE RFQ

A simple plug tuning mechanism was simulated to investigate the total tuning range possible using a plug designed to fit within a KF40 flange. Fig. 4 shows the model with all four tuning plugs pushed all the way in, giving the maximum effect on the resonant frequency.

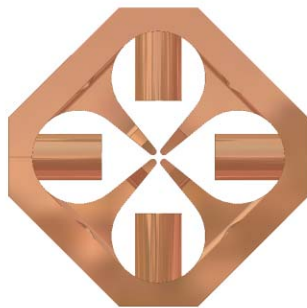

Figure 4: 4-vane model with four tuning plugs pushed all the way in.

Fig. 5 and Fig. 6 show the variation of the resonant frequency and Q-value, respectively, with the distance that the tuning plugs have been moved in.

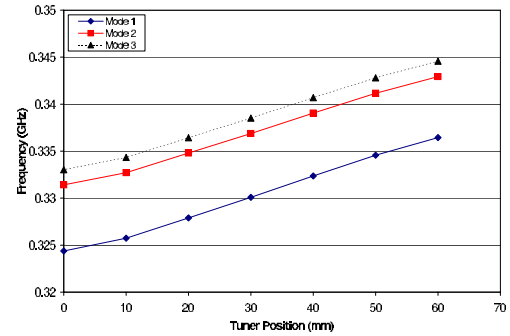

Figure 5: Plot showing the variation of the resonant frequency, of the first three modes, with the position of the tuning plugs.

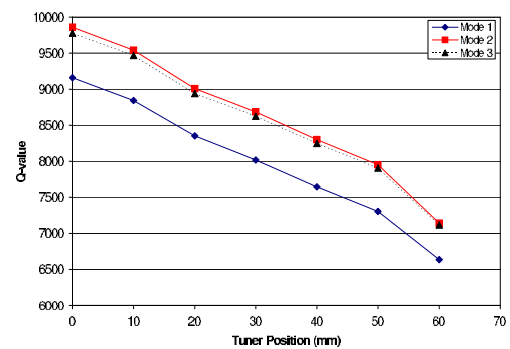

Figure 6: Plot showing the variation of the Q-value, of the first three modes, with the position of the tuning plugs.

## CUTAWAY OPTIMISATION

A delay in the schedule for the manufacture of the 4-vane cold-model allowed some optimisation of the vane cutaway region to be done. Fig. 7 shows the surface current distributions for the old and new models. While both show uniform wall losses over most of the inner surface, the original cutaway design shows more localized heating near the vane tip, which would require cooling. The new cutaway design has surface currents concentrated away from the vane tips where machining of cooling channels is much easier.

## SIMULATIONS OF A 4-ROD TYPE RFQ

A design similar to the ISIS RFQ [2] was first used for the simulations. Fig. 8 shows the parameters (and their final values) that were varied to obtain a resonant frequency of 324 MHz. This compact design allows for many cooling channels, since the distance between the stems is relatively small. However, this could affect the ability to efficiently couple in rf power.

Fig. 9 shows the surface current distribution for this model. This shows that this 4-rod design has localized

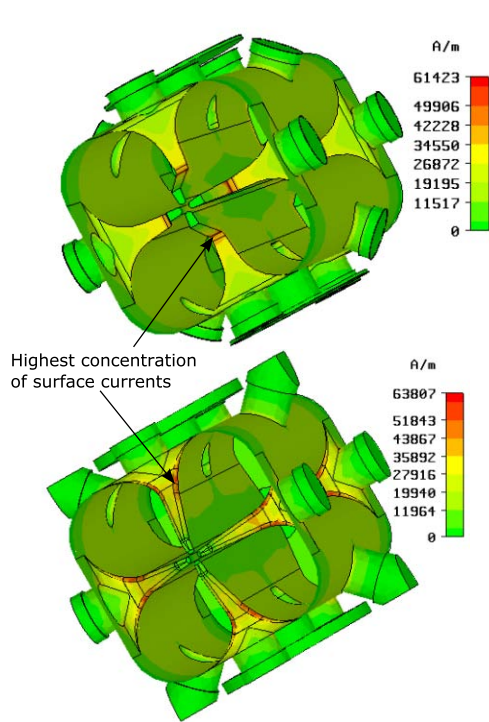

Figure 7: Surface current distributions showing the old cutaway shape (top) and the new cutaway shape.

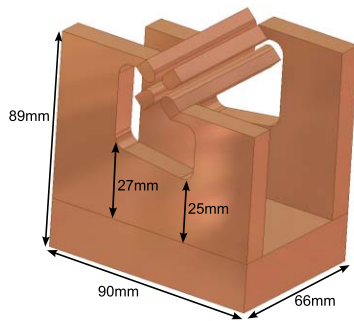

Figure 8: 4-rod Model.

Table 1: Results for the first three eigenmodes of the 4-rod simulation.

Mode	Frequency (MHz)	Q-value
1 (quadrupole)	323.7	4323
2 (dipole)	526.8	3751
3 (dipole)	536.4	4013

heating near the join between the rod and the stem, which is a critical region. Some preliminary thermal studies have been done to investigate cooling of the stems [4].

This model was then modified to include cooling blocks and filleting of the edges. Simulations with various 4-rod designs are currently ongoing.

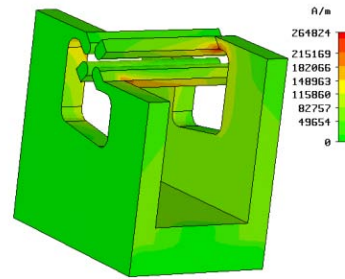

Figure 9: Surface current distribution for the simple 4-rod design.

### CONCLUSIONS

The simulations of the 4-vane RFQ produced a model with a resonant frequency of  $(324.0 \pm 1.2)$  MHz and a Q-value of  $(8782 \pm 133)$ . A conservative estimate of the errors was made by taking the RMS of the results from Fig. 2 and Fig. 3. The adjacent dipole mode is separated by 7.1 MHz and therefore should not overlap with the quadrupole mode. Using four simple tuning plugs showed that the expected tuning range is 12 MHz. Thus, to tune the RFQ by 1.2 MHz requires moving the tuning plugs by 6mm, which corresponds to a change in the Q-value of 243. To allow tuning in both directions, the model has to be built for a lower resonant frequency and operated with the tuning plugs partially in. However, this will mean operating at a lower than ideal Q-value.

A cold-model of the 4-vane RFQ is already in construction [4] and the 4-rod cold-model will follow shortly after. The 4-vane cold-model is based on the optimised cutaway simulations. However, since the material had already been purchased, it was not possible to increase the model size to obtain a resonant frequency of 324 MHz. Therefore, the cold-model is expected to have a resonant frequency of  $(334.4 \pm 1.2)$  MHz.

Initial simulations with the 4-rod design showed that there is localized heating around the critical region between the rod and the stem. Further simulations are being done to reduce the localized heating and to investigate the efficacy of different cooling options.

### REFERENCES

- [1] B. Krietenstein, R. Schuhmann, P. Thoma, T. Weiland, "The Perfect Boundary Approximation Technique Facing the Big Challenge of High Precision Field Computation", LINAC'98, Chicago (1998), p. 860.
- [2] H. Vormann, A. Schempp, U. Bessler, C. W. Planner, A. Letchford, "A New High Duty Factor RFQ Injector for ISIS", EPAC'98, Stockholm (1998), p. 782.
- [3] A. Letchford, "A Comparison Of 4-Rod and 4-Vane RFQ-Fields", EPAC'98, Stockholm (1998), p. 1204.
- [4] P. Savage, Y. A. Cheng, A. Letchford, J. K. Pozimski, "Mechanical Design and RF Measurement on RFQ for Front-end Test Stand (FETS) at RAL", these proceedings.