



Science & Technology  
Facilities Council

# 10 Years of ALICE : From Concept to Operational User Facility



Science & Technology Facilities Council

Daresbury Laboratory

*Peter Williams*

*On behalf of the ALICE team*

*8<sup>th</sup> June 2015*





# Daresbury Laboratory

- ALICE is an ERL-FEL at STFC's Daresbury Laboratory in North-West England
- Daresbury Laboratory was established in 1964 to host NINA – a 6 GeV electron synchrotron for high-energy physics, then developed the first dedicated X-ray synchrotron light source (SRS 1980-2008) and designed UK's 3<sup>rd</sup> gen source, (Diamond 2007-...)
- ALICE sits in reused experimental areas of the Nuclear Structure Facility tower (20 MV tandem Van-de-Graaf 1981-1991)
- ALICE is **A**ccelerators and **L**asers **I**n **C**ombined **E**xperiments and was formerly known as ERLP – Energy Recovery Linac Prototype
- Lewis Carroll – author of “Alice in Wonderland” was born in 1832 in the Parsonage of Daresbury Church – adjacent to the laboratory



# The dim and distant past...

- Ambitions to host an FEL at Daresbury date back to 1978: Meeting on a balcony in Frascati - [Mike Poole](#), John Madey, Todd Smith, Claudio Pellegrini, ...
- Many false starts:
  - FELIX at Daresbury (1980 – not funded)
  - UK-FEL in Glasgow (Built 1983-1986 – not operated)
  - Oxford FEL (1990 – not funded)
  - FELIX - Nieuwegein, Netherlands (Operational 1991 – present) re-used UK-FEL expertise and undulator
- 1986 Blundell Report then 1993 Woolfson Report for UK Government on SR provision:
  1. ESRF for hard X-ray
  2. Diamond for soft X-ray
  3. “Access to brilliant VUV radiation...a new low energy source, which would be unique, should be pursued...”
- This “three ring circus” concept was reiterated in through the 1990’s, driven by ambitions of UK synchrotron user community
- At first storage rings – SINBAD and DAPS, were proposed, then the potential of FELs started to gain traction



**FELIX**  
Free Electron Laser  
for  
Infrared eXperiments



First FEL worldwide  
which  
- was really tunable  
- worked “every day”

# 2000: A MHz Rep Rate XUV/VUV/IR User Facility?

- **2000:** Daresbury responded to this challenge with a proposal for a new combined XUV, VUV and IR facility - 4GLS
- Key concept was a VUV-FEL driven by a **CW-Energy recovery linac** for high peak, high average power

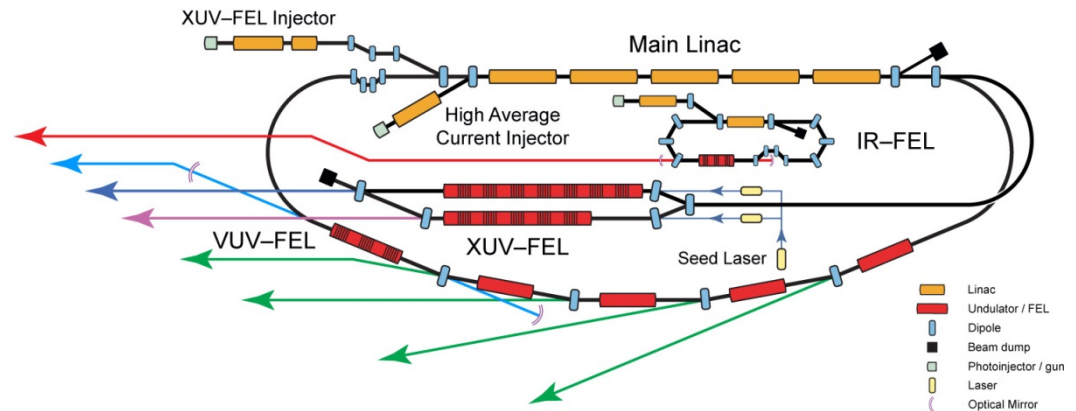

- **2003:** We had a lot to learn, so as part of the proposal, funding was provided to **construct a prototype ERL machine** (ERLP → now ALICE).
  - Gain experience with assembling and operating TESLA cavities and cryomodules, and the associated cryogenics and controls technology
  - Develop and operate an energy-recovery system, including issues such as RF, synchronisation and optics.
  - Develop photoinjector technologies
  - Develop technologies for operating oscillator free-electron lasers (FELs)
  - Develop an understanding of bunch compression and associated beam transport issues in combination with simulations.
  - Develop diagnostics techniques and instruments for use on 4GLS.

# 2003: Design an Energy Recovery Linac Prototype

- Site in reused experimental areas -> many layout restrictions
- Extensive collaboration with JLab who had just had IR-upgrade funded
- 350 kV DC photocathode gun based on JLab design
- 2K LHe Cryosystem with 120 W capacity
- 2 Stanford / Rossendorf cryomodules (Booster 8 MeV, 52 kW; Linac 27 MeV, 13 kW)
- Arcs – moveable TBA chosen over Bates, one compression chicane chosen over two
- Oscillator FEL using JLab IR-Demo wiggler re-engineered for variable gap
- 9 m optical cavity at 5<sup>th</sup> subharmonic of 81.25 MHz rep rate

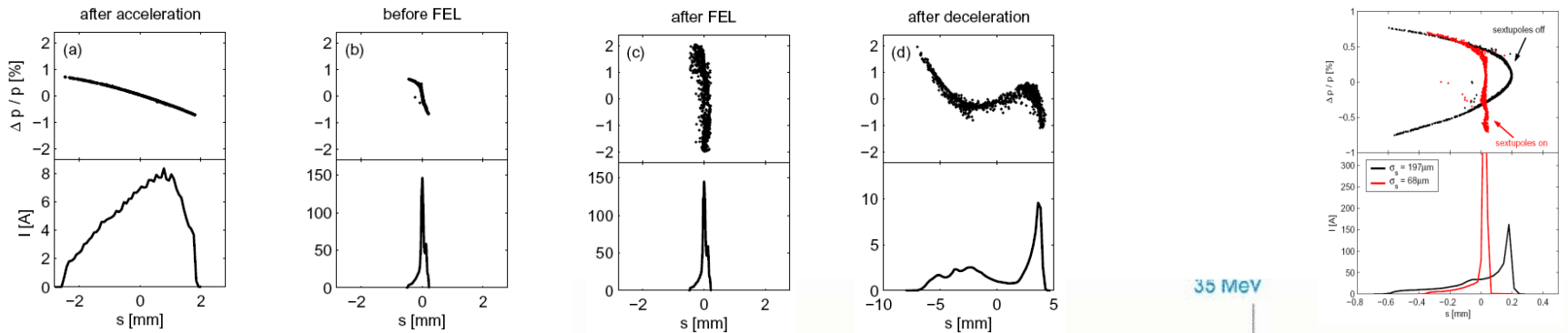
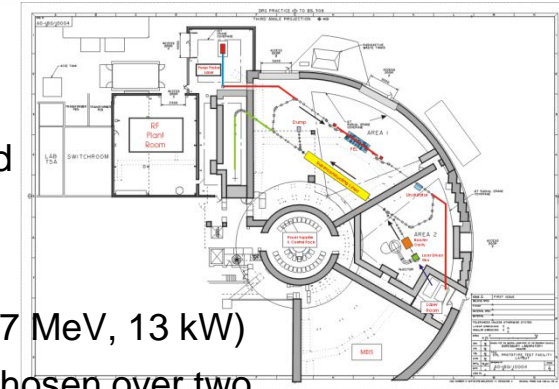

- The intention was to run ERLP for ~18 months then reuse components in 4GLS...

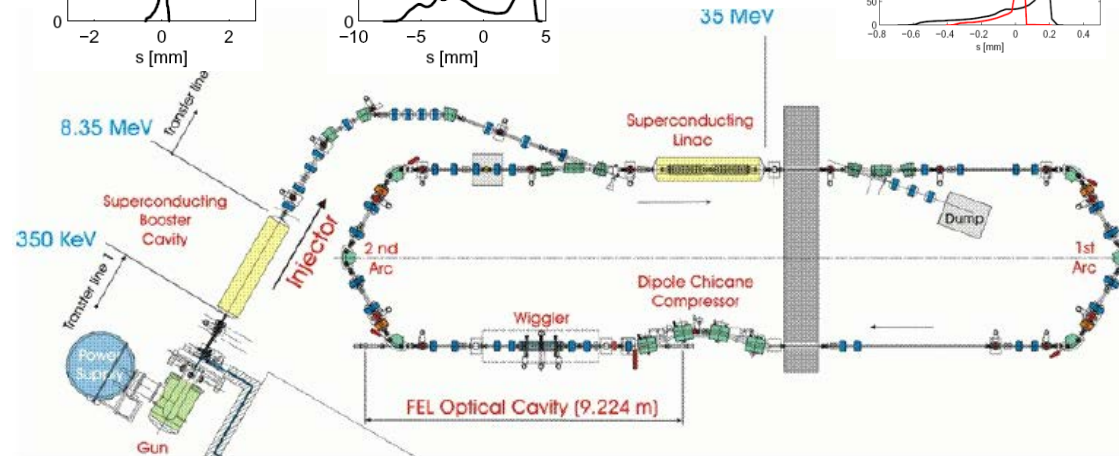

# 2004/5: Procurement & Construction

- **2004**
  - Photoinjector laser system commissioning
  - Layout and component specification completed
  - Magnets, IOTs, gun, SF6 vessels, DC HV delivered
- **2005**
  - Gun HV PS assembled
  - Problems with gun ceramic
    - > remanufacture,
  - Problems with buncher
  - TW laser installed for CBS demo

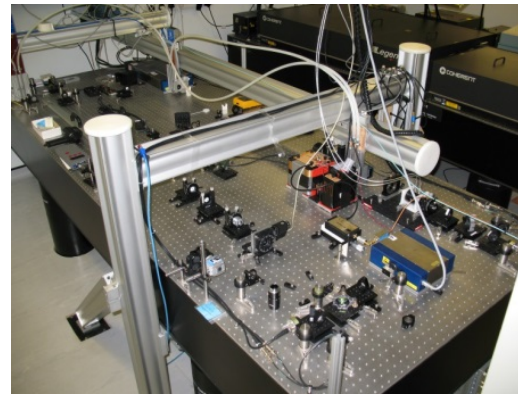

# 2005/6: Installation, Gun Commissioning

- Booster module is swung to the side to allow for gun diagnostic beamline

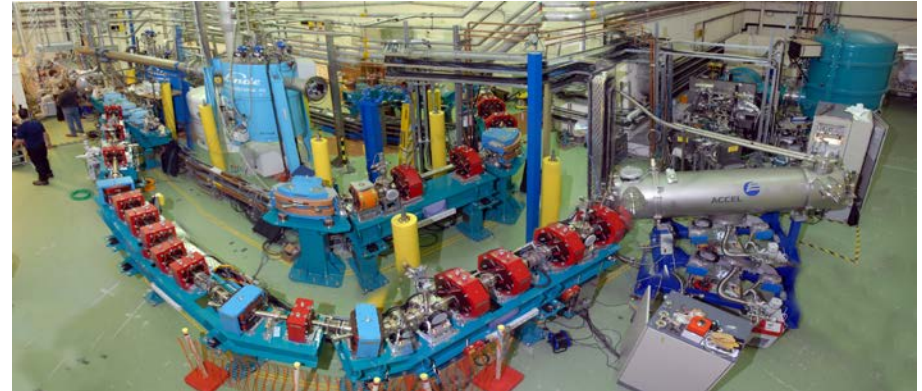
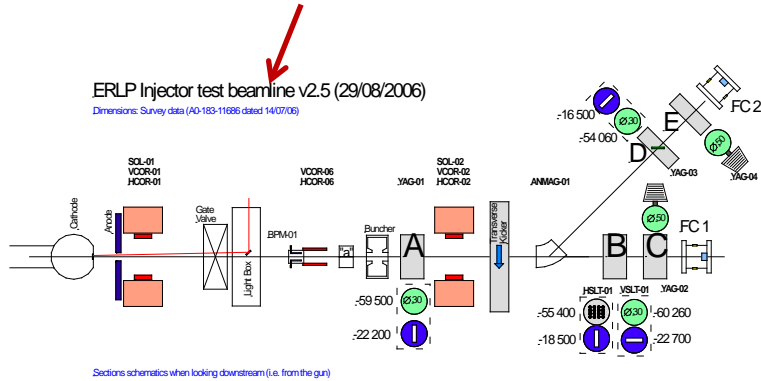

- The first beam! – 16<sup>th</sup> August 2006

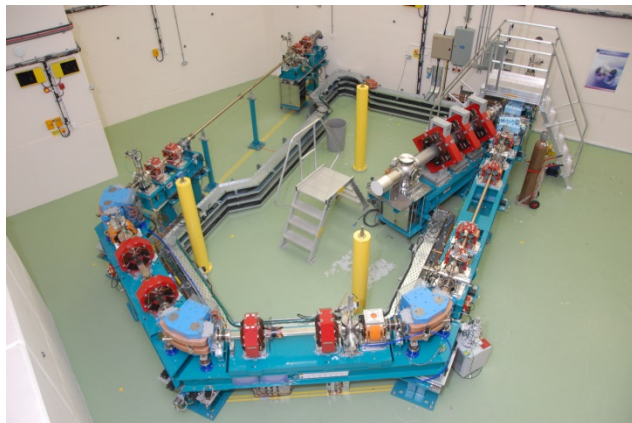



# 2007: Gun Problems, RF & Cryo Commissioning

## Gun:

- Strong field emission from the cathode and rapidly deteriorating QE, non-uniform QE map
- Mechanical failure inside the cathode ball (flap)
- Conditioning resistor failure
- Second cathode also suffered rapid QE deterioration
- Contamination after each cathode activation
- Gun disassembled then vacuum leak
- Nevertheless by end 2007 – 100 pC achieved (QE>3%) and full characterization at 350 keV

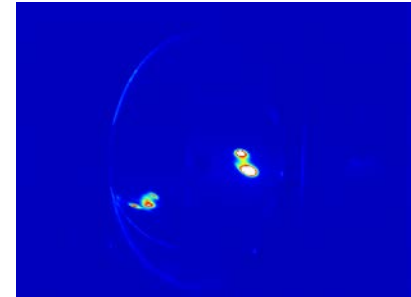
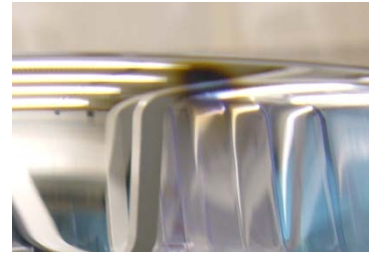

## RF:

- Significant field emission within linac limits gradient – additional shielding to protect control rack, ALICE operates at 27 MeV rather than 35 MeV
- Booster IOT co-axial couplers – too risky for CW -> macropulse

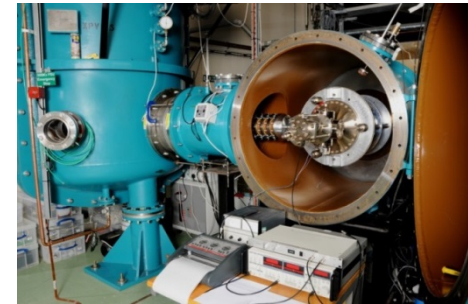

## Cryo:

- Rebuild of transfer lines
- Cooldown rates inadequate
- 2K recuperator heater failures
- Contamination
- Leaks...

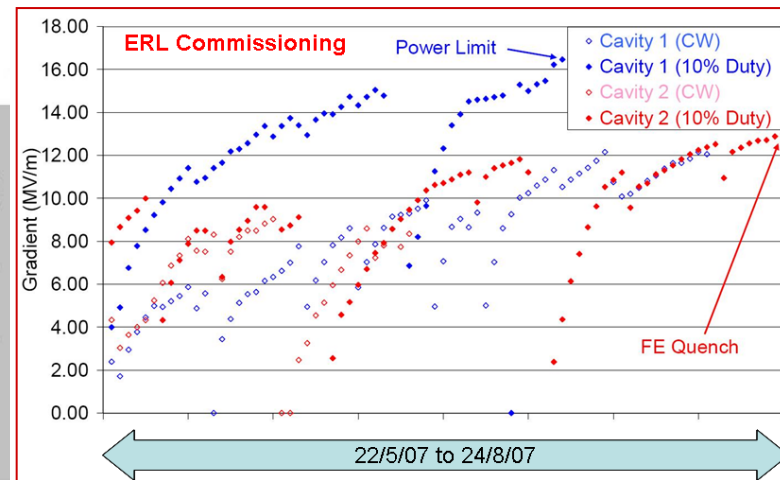
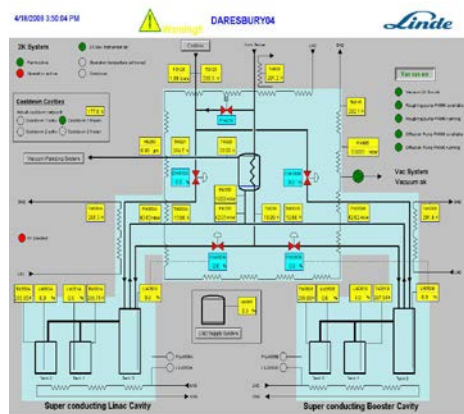

# 2008: Energy Recovery

- Booster cryo-module sent for repair at ACCEL (January-March)
- Isolation window failure, IOT PS issues
- 4GLS cancelled – ERLP renamed ALICE
- Stanford U. (Todd Smith) ceramic with smaller diameter installed in the PI gun (June) → **230kV only**
- First beam through the booster in October, first beam through the linac in December
- Just before Christmas **full energy recovery** at 20.8 MeV - just ~10 pC bunch charge, 80 pC achieved in 2009 – efficiency > 100% (i.e. possible to dump at less than injection energy)



The gradient demand traces from the two linac cavities (original analogue LLRF system) as pop-in dump in return path is retracted

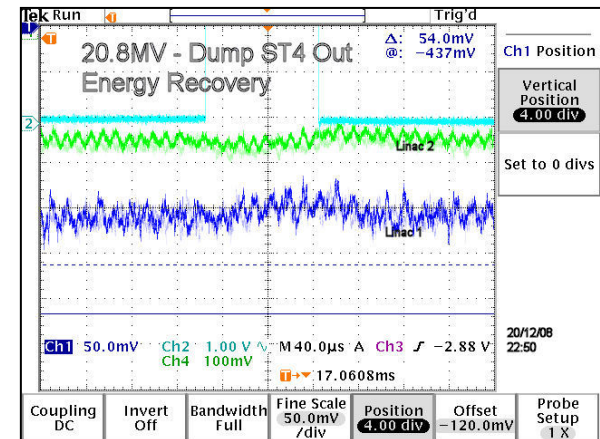
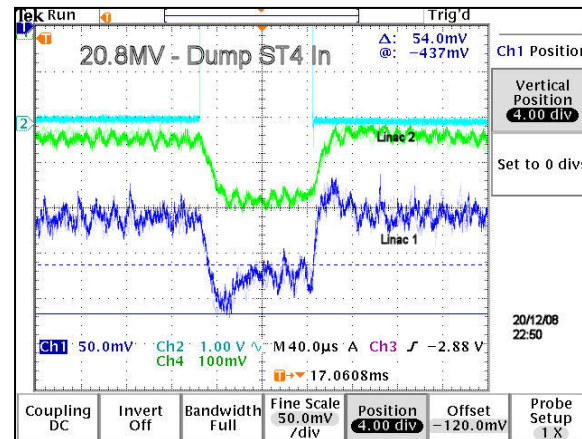

# 2009: First Exploitation – THz, CBS

## Commissioning progress:

- Full cathode re-activation and elimination of vacuum leak → QE ~ 4% ; >80pC ; long lifetime
- Kr based “plasma cleaning” of the gun → removed most field emission on cathode ball
- LLRF optimisation to alleviate beam loading → 40pC; 81MHz; 100us
- RF cavities conditioning and RF pulse reduction → operation at up to 30MeV possible

## Coherent THz:

- Broadband (peak at 0.3 THz) radiation from 1 ps bunch at compressor dipoles 3 & 4

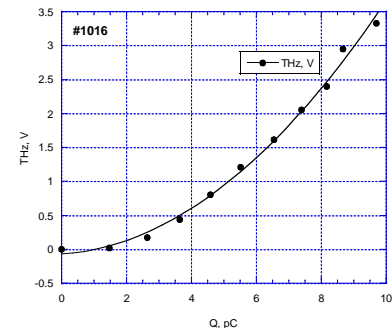
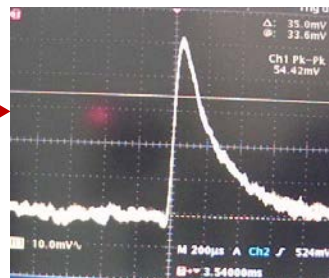

## Compton back-scattering demonstration:

- TW laser produced X-rays in head on configuration
- Image shows X-rays detected on screen ( $10^3$  per macropulse)
- Plot shows X-ray intensity as laser timing scanned

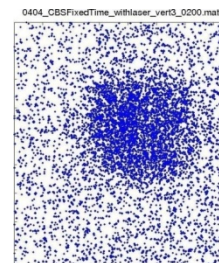

## Undulator Installation:

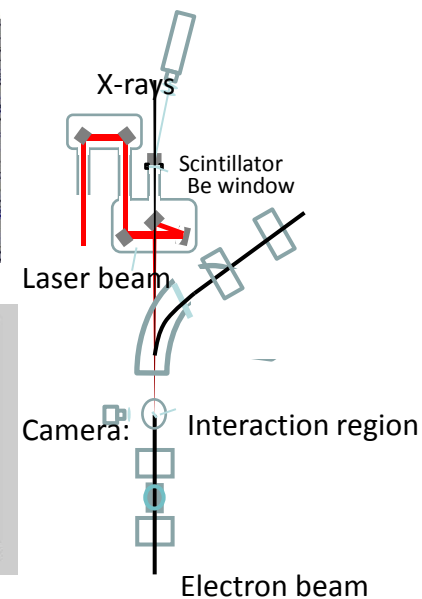
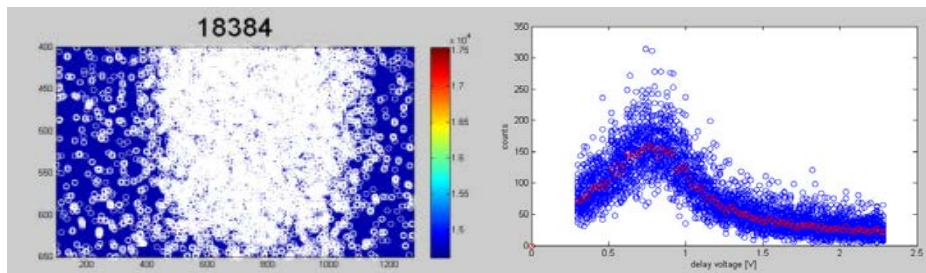

# 2010: The Lead-Up to Lasing

- **Helium processing of linac cavities:**  
Improvement in field emission onset in linac cavity after processing

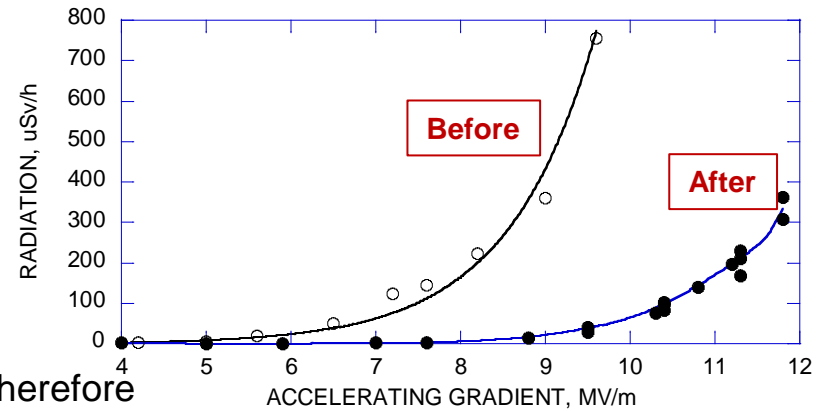

- **PI laser burst generator installation:**  
Second Pockels cell in series allows pulse picking and therefore  $< 81\text{MHz}$  operation, enables  $Q = 60\text{pC}$  standard and  $> 100\text{ pC}$  possible



- **THz cells exposure:**  
Experimental programme to investigate effect of intense THz on living tissue in an incubator located in the accelerator hall

- **EMMA ring:**  
ALICE used as an injector for world's first Non-Scaling FFAG and completed many turns – of interest here, but not the subject of this talk!

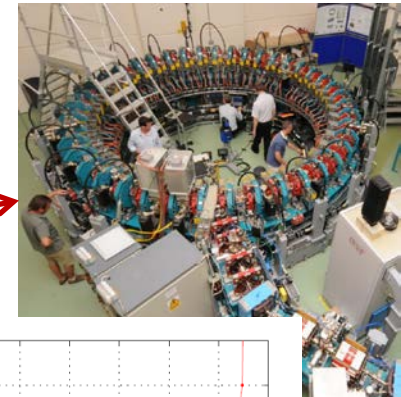

- **FEL preparation:** Cavity mirrors installed and aligned, first observation of spontaneous emission. Radiation was stored in the cavity immediately, indicating the transverse pre-alignment was reasonable. Spectrometer installed and tested. Strong coherent emission seen with dependence on cavity length...

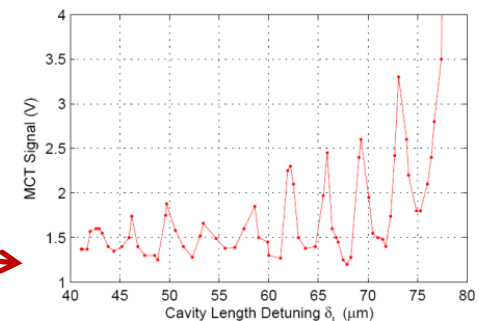

# 23<sup>rd</sup> October 2010: ALICE FEL First Lasing



**Lasing**  
**100-40 pC @**  
**16.25 MHz**

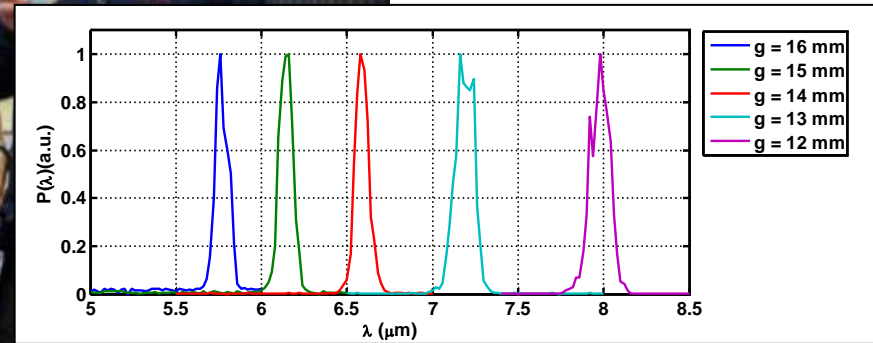

**First Lasing Data: 23/10/10**

**Simulation (FEL code)**

Continuous tuning 5.7-8.0 μm, varying undulator gap

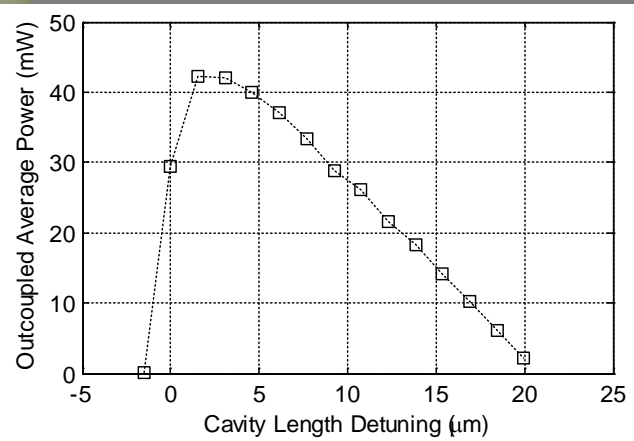
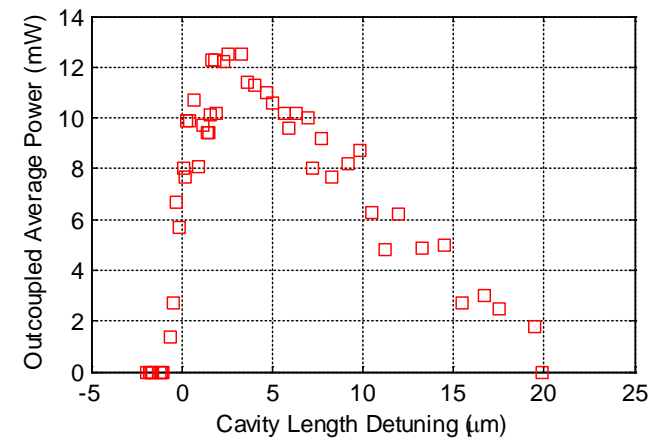

**The peak power ~3 MW**  
**Single pass gain ~20 %**

# 2010 Onwards: Diagnosing the IR-FEL output

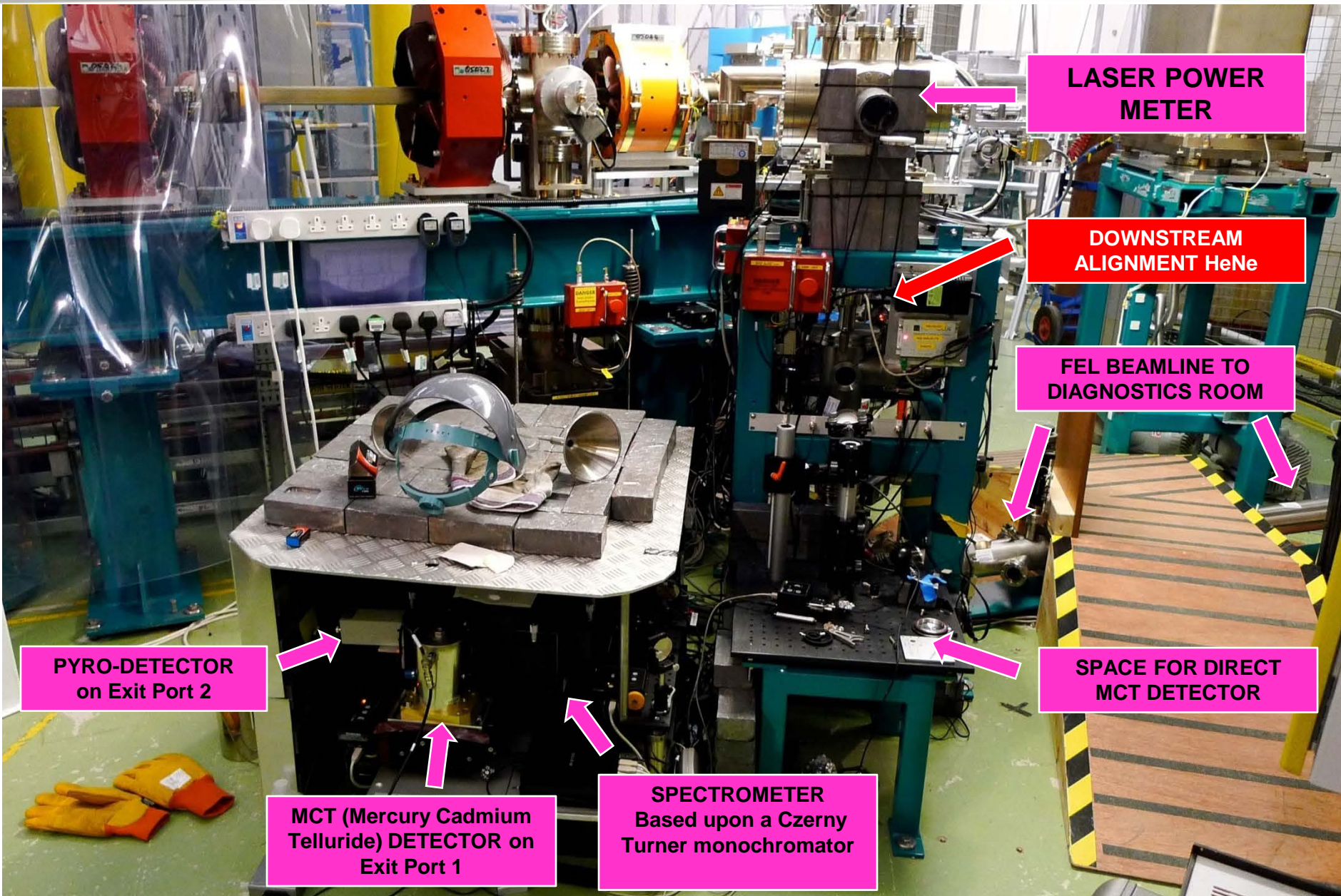

# 2010 Onwards: Diagnosing the IR-FEL output

- **Power meter** (Thermocouple measurement of FEL average power)
- **IR Camera** (Transverse profile of radiation)
- **Mercury Cadmium Telluride detector** (Sensitive liquid-nitrogen cooled detector, used to measure spontaneous radiation, and for optimisation through to lasing)
- **Photoelectromagnetic (PEM) detector** (Fast-response - can resolve individual FEL pulses within a train when lasing, image shows gain measurement by fitting to pulse intensities)

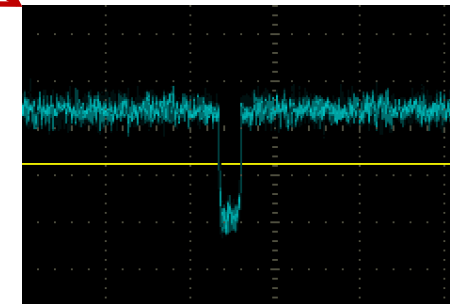
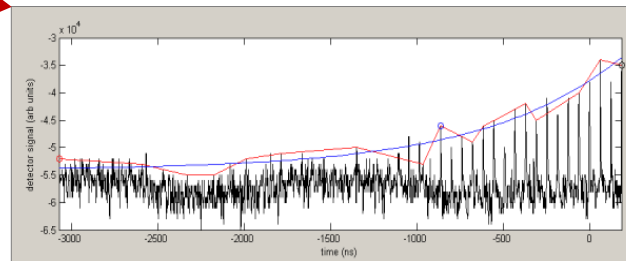
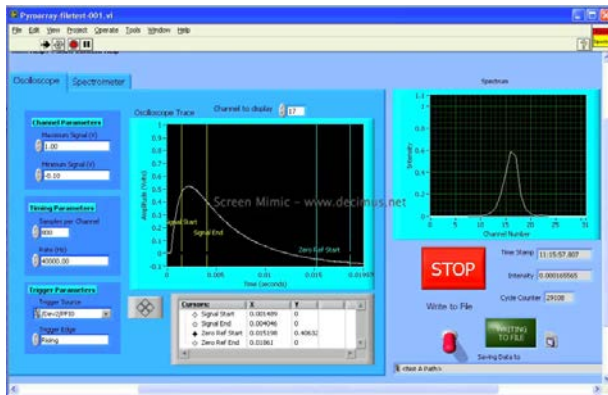
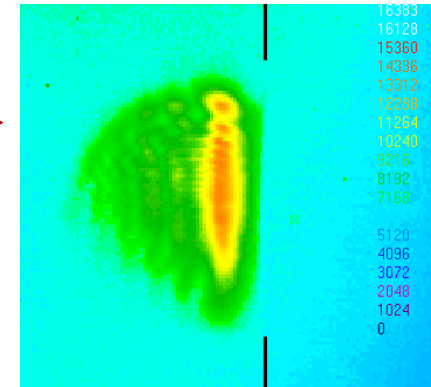

- **Spectrometer** (LabView program used for real-time recording of the IR spectrum measured by the pyroarray)
- **Post-FEL OTR images** (Electron bunch transverse profile in dispersive locations after the FEL, calculate FEL-induced energy loss + spread)

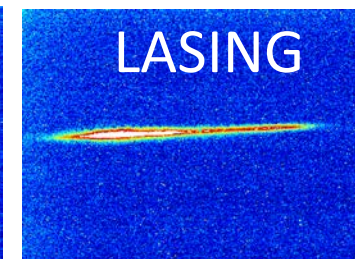

# 2010 Onwards: Typical ERL & FEL Parameters

Full Energy (MeV)	24-27
Injector Energy (MeV)	6
Bunch Charge (pC)	60 – 80
Micropulse rep. rate (MHz)	16.25 / 32.5
Macropulse length ( $\mu$ s)	85 + 15 startup
Number of micropulses / macropulse	1400 / 2800
Macropulse rep. rate (Hz)	10
Wavelength range ( $\mu$ m)	5.5 – 11
Micropulse energy at sample ( $\mu$ J)	2
Peak power at sample (MW)	2
Av. Power within macropulse (W)	20
Av. Power (mW)	40
Linear polarisation	>95%
Power stability	~0.2 – 1 %



# 2011: User Runs Commence

- Machine Development:  
Electro-Optic system confirms 1-2 ps bunch lengths after compression – individual pulse profiles

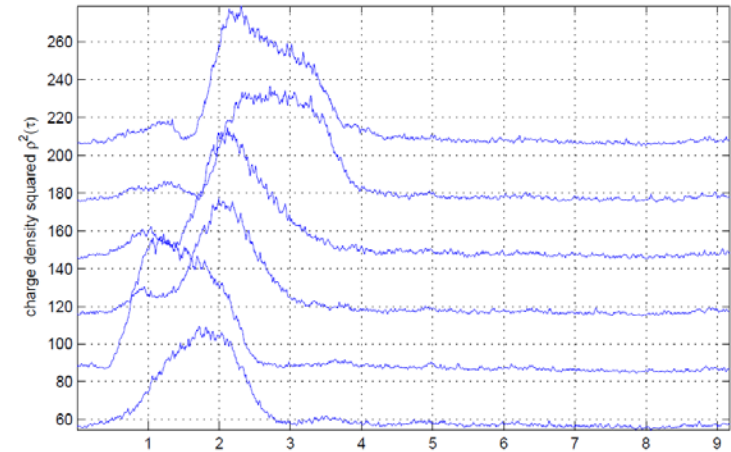
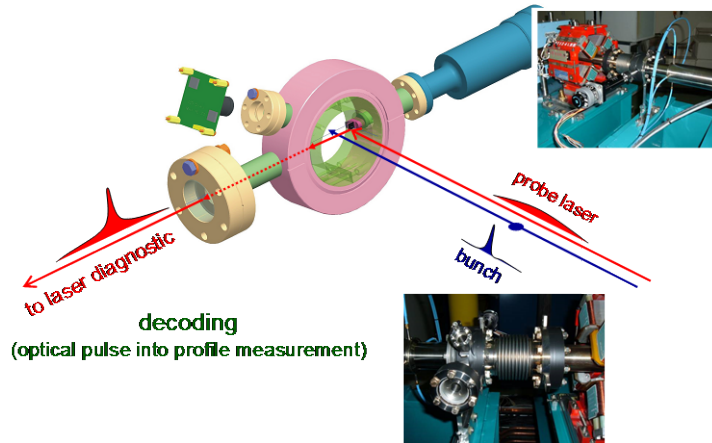

- Commissioning of THz and FEL user beamlines:  
THz beam transported to a Tissue Culture Lab  
Biological experiments to determine safe limits of exposure of human cells to THz and effect of THz on differentiation of stem cells

Estimate **> 10 KW** in single THz pulse  
with **~ 20%** transport efficiency to TCL

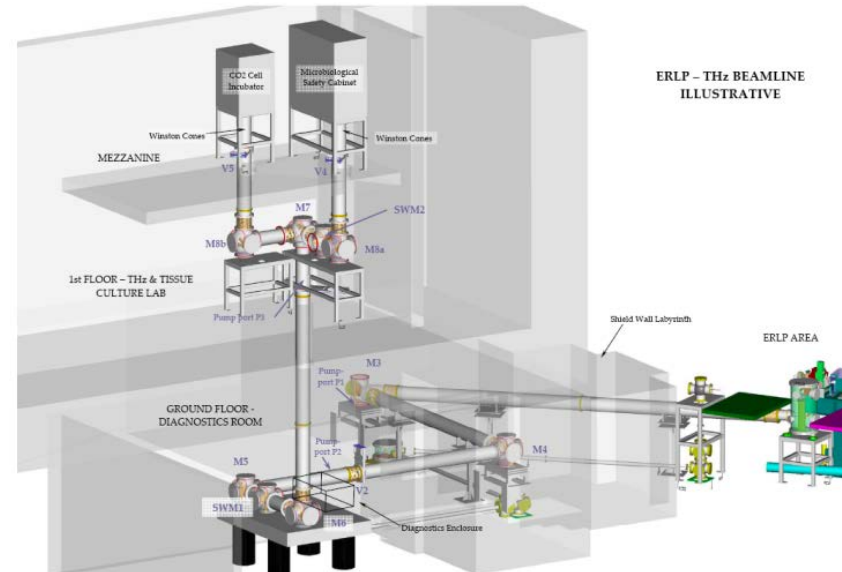

# 2011: FEL Integration with SNOM

- **FELIS:**  
Scanning Near-Field Optical Microscope installed and integrated with IR-FEL beamline
- **Motivation:**
  - **Oesophageal adenocarcinoma** is the fastest rising incidence of cancer in the western world and survival rates are very poor
  - Oesophageal adenocarcinoma often progresses from **Barrett's oesophagus**: lining of the oesophagus is damaged by stomach acid and changed to a lining similar to that of the stomach.
  - **The challenge is to identify patients with Barrett's oesophagus who will develop oesophageal cancer.**
- Present method of diagnosis:
  - Subjective
  - Patterns difficult to interpret
  - Biopsy may not be representative

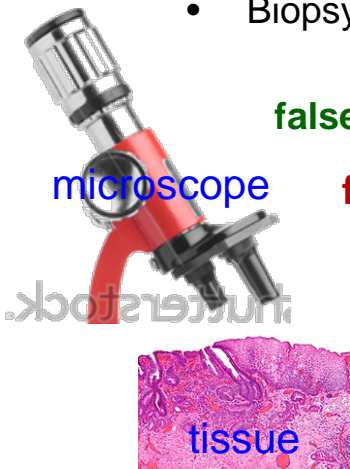
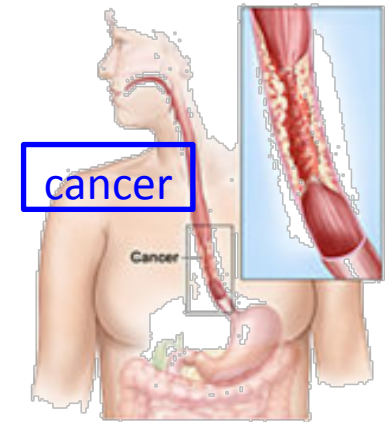

false positive -> patient has unnecessary surgery

false negative -> patient dies

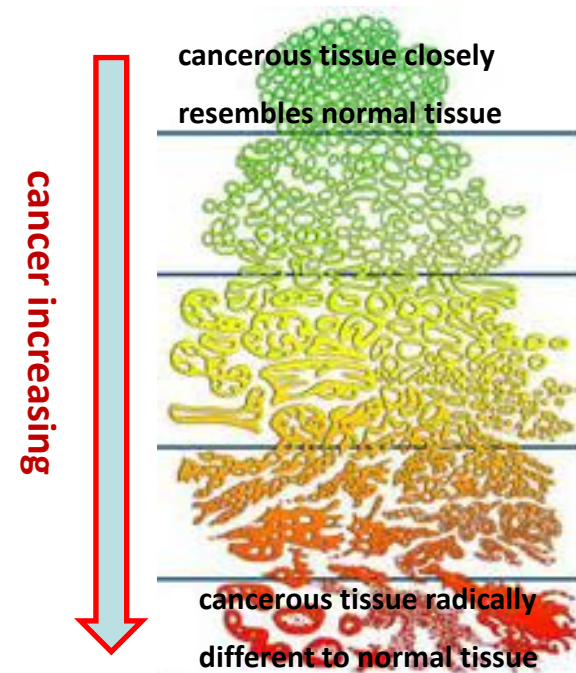

# 2011: FEL Integration with SNOM

- **Potential solution: Spectroscopy and microscopy in the IR**

- The different components of tissue have different IR spectra
- Traditionally the weakness has been resolution  $\sim \lambda/2 \sim 3\text{-}4 \mu\text{m}$  – but the features are  $\sim 10 \text{ nm}$
- The SNOM overcomes this by working in the near field
- A tapered optical fibre probe is placed within a fraction of a wavelength in close proximity to a sample and scanned
- The spatial resolution is now given by the tip diameter
- However, there is strong reduction of the intensity due to the aperture of the fibre
- So the technique needs a high-intensity tune-able IR source – **ALICE FEL**
- Image cluster analysis at 3 wavelengths selected to differentiate the components and quantify the “spreaded-outness” of DNA  $\rightarrow$  diagnosis

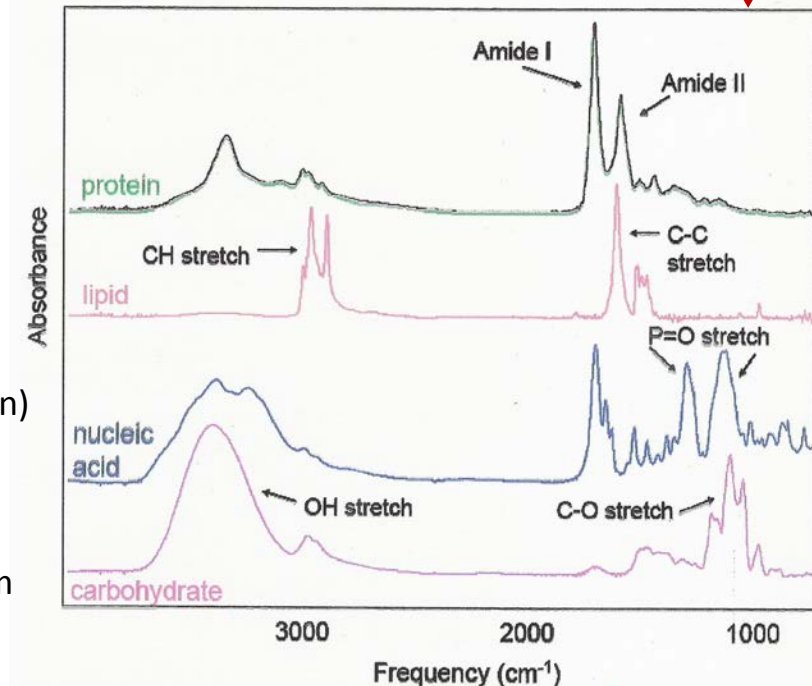
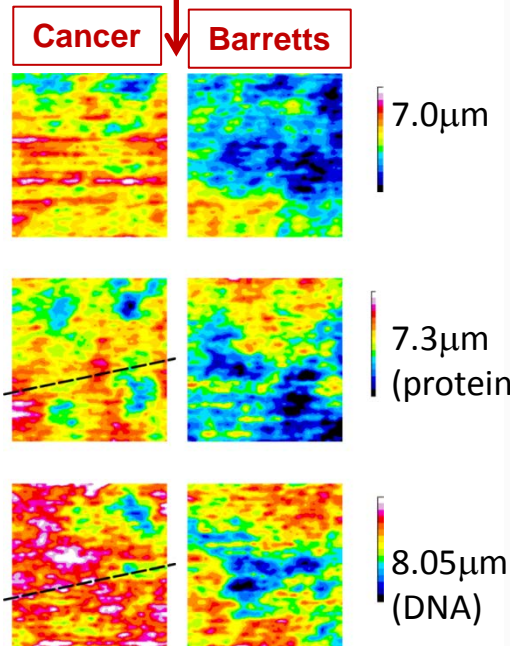
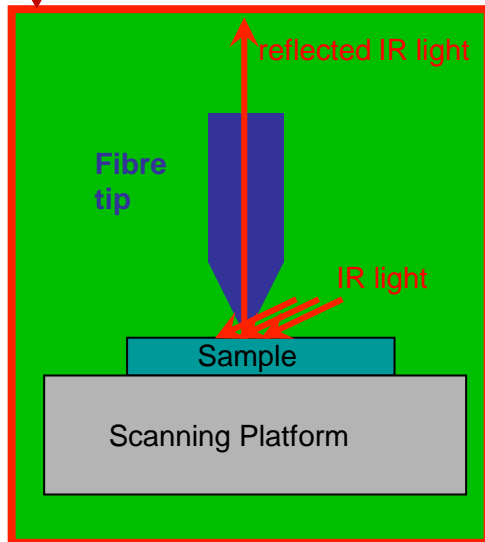

# 2012: Gun Upgrade

- HV DC photoelectron gun upgraded with installation of larger diameter ceramic as originally intended, followed by successful gun HV conditioning to >400kV

**Operational voltage : 230kV → 325kV**

- Field emitter on the cathode was evident (could not be conditioned) -> **Cathode changed in May 2012** : much better “workable” cathode, running lifetime of 2-3 days, smooth QE map – Still there in 2015!
- Beam quality much improved, two “beamlet” structure at 230 kV nearly disappears, normalised emittance reduces and more robust

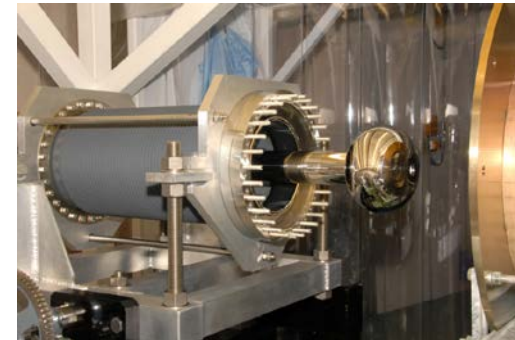
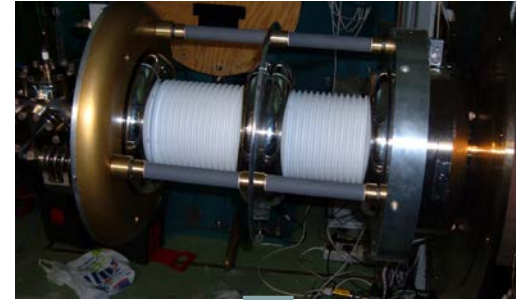

**At 230kV DC gun voltage**

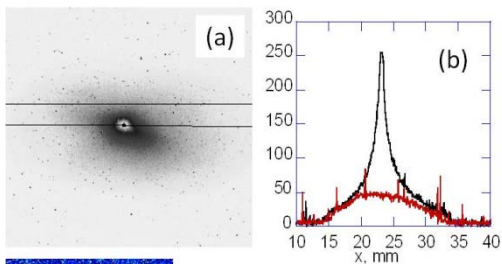

**Improved QE map**

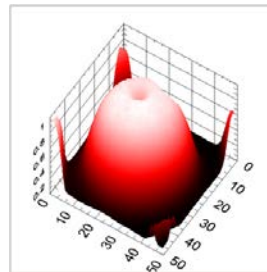

**At 325kV DC gun voltage (injector spectrometer)**

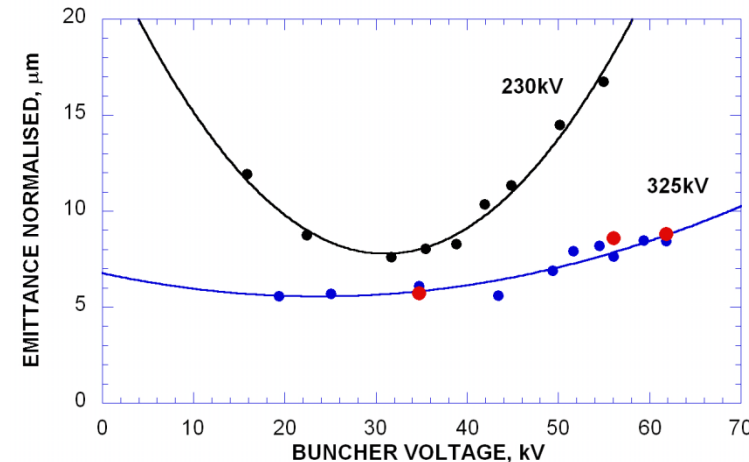
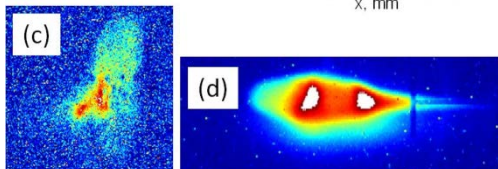

# 2012 Onwards: Accelerator Physics (Transverse)

Our understanding of ALICE expands:

- Confirmation of post-linac beam optics  $\longrightarrow$
- Beam tomography post linac  $\longrightarrow$

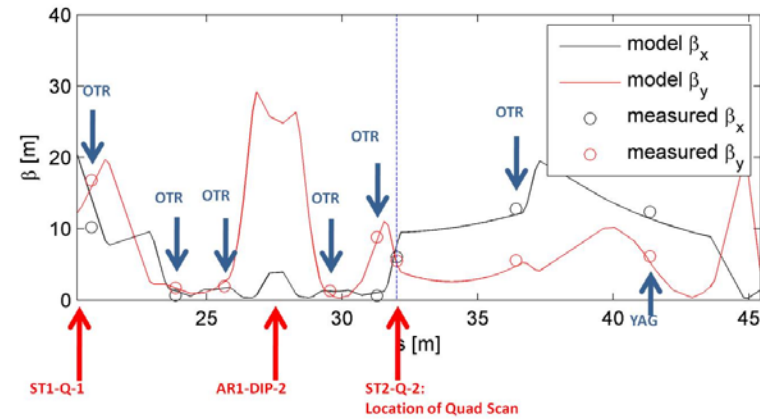
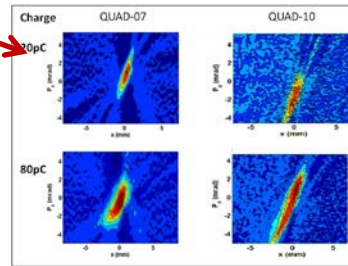

- Full model in GPT including space-charge

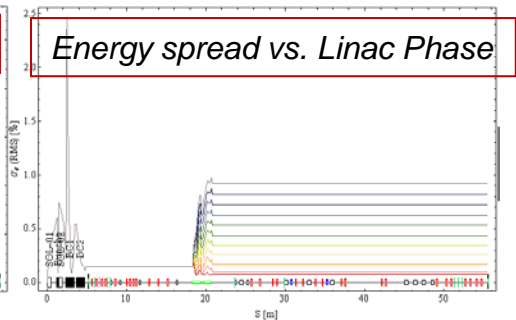
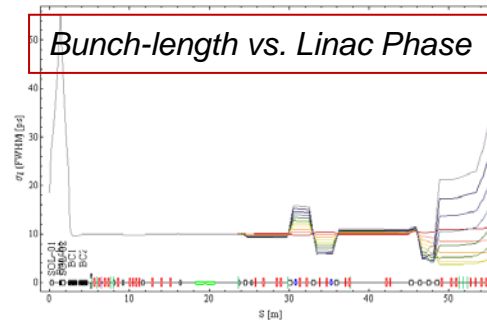
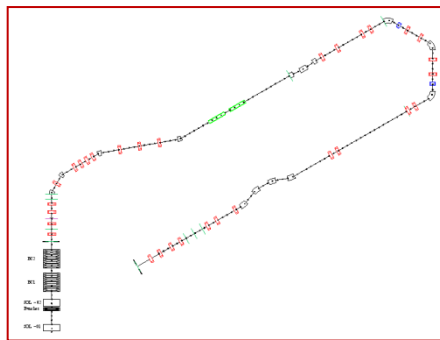

- Effect on THz emission of  $R_{51}, R_{52}$

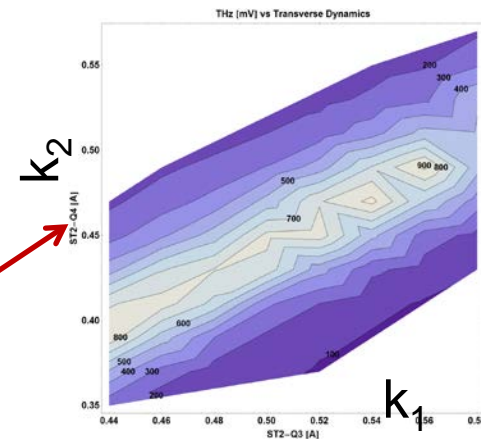
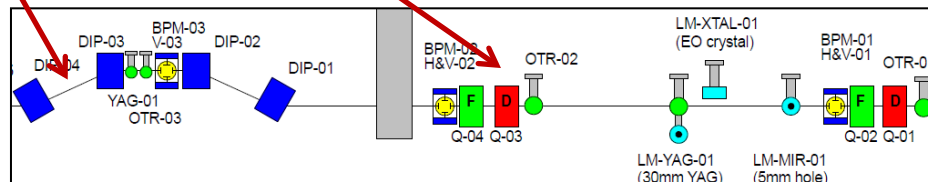

# 2012 Onwards: Accelerator Physics (Longitudinal)

- Injector zero-phasing method bunch length; bunch "quality factor" measurements

- Linac phase scan bunch length

- Injector model validation

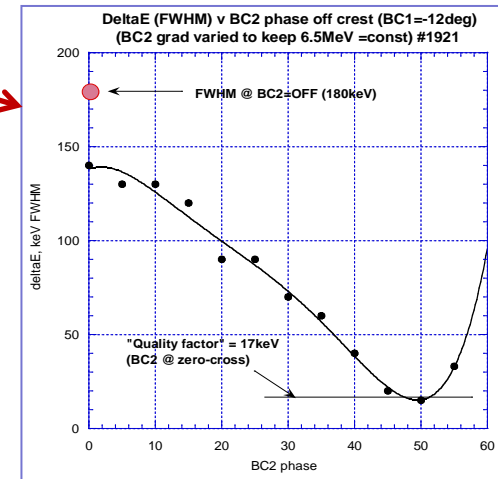
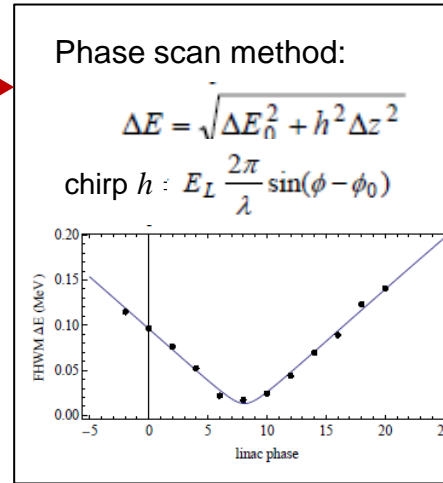
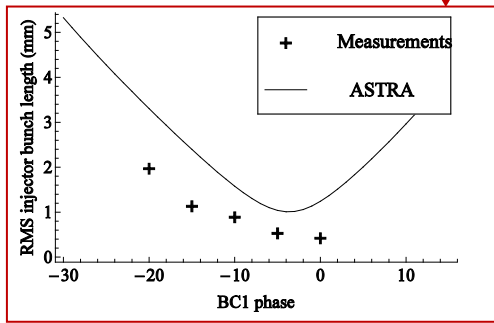

- Time-of-arrival measurements allow tuning of  $R_{56}$  and  $T_{566}$  of lattice

TOA v sextupoles strength in Arc-1 ->  $T_{566}$

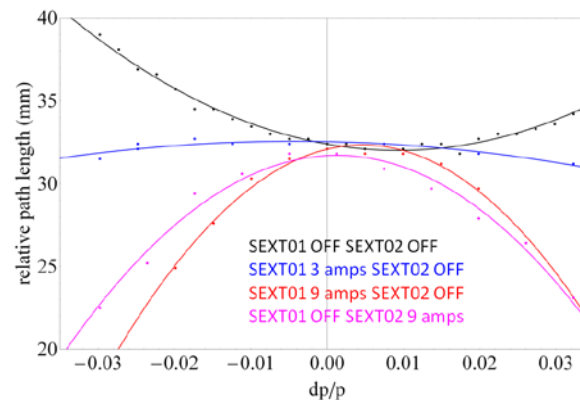

$R_{56}$  v quadrupole strength in Arc-1 and BC

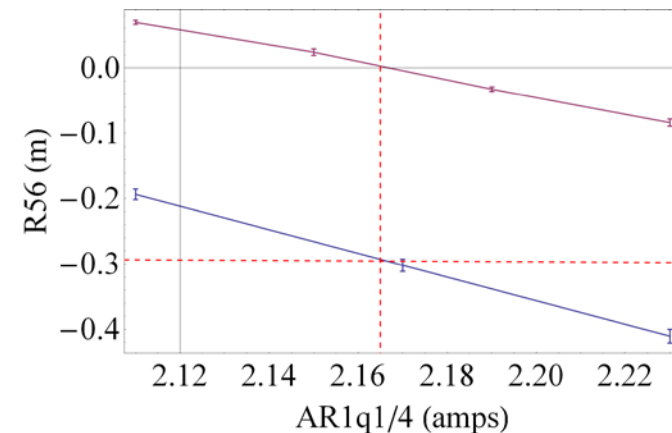

# 2012 Onwards: Accelerator Physics (Longitudinal)

- Two distinct positional peaks in THz intensity -> bunch becomes short in dipole 3, larger peak at dipole 4 shows majority of emission when dispersion suppressed

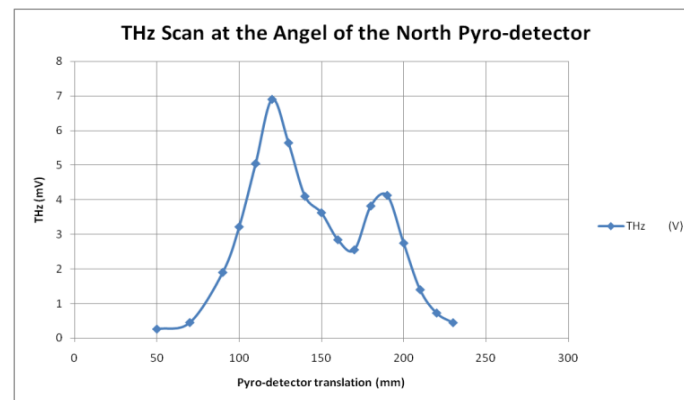
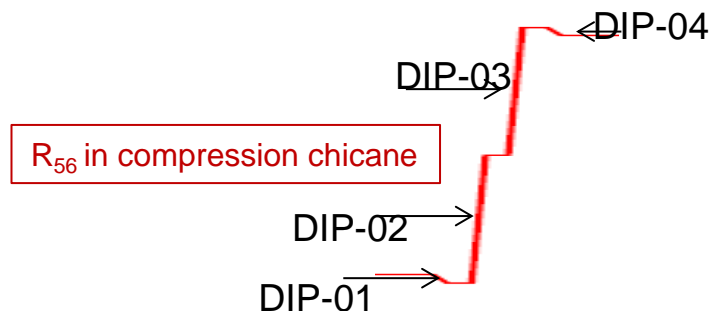

- Bunch-by-bunch BPM and FEL fast diagnostics -> Stability from train to train and within train -> **See Frank Jackson WG3 Wednesday**
- Using the energy recovery dump to diagnose the transport (here we see the FEL gain time through an energy drop on edge of FCUP and change in BPM position as lasing initiates (point-to-parallel decompression in ARC-2 is detuned))

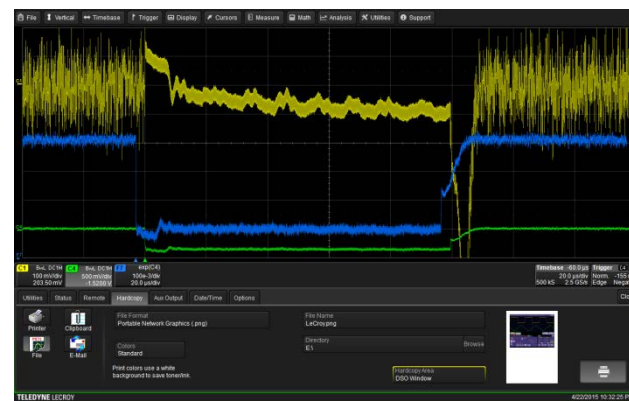
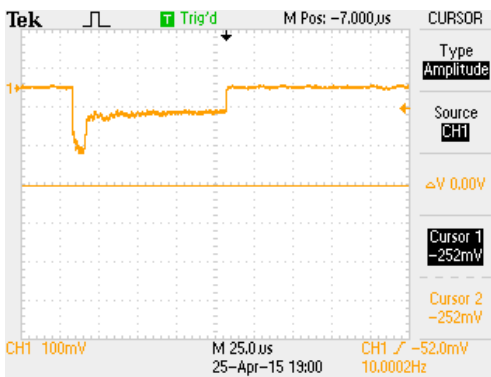
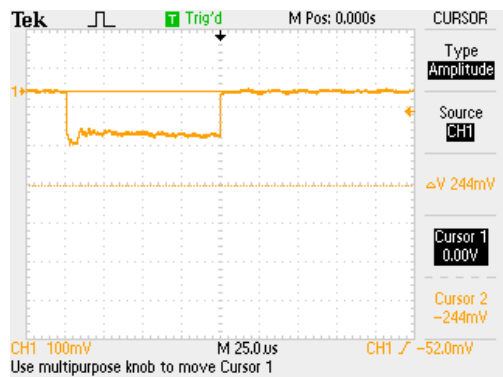

# 2013: DICC and Major Cryo Failure

- As part of longstanding effort to validate DICC 7-cell ERL cryomodule much of 2013 dedicated to installation

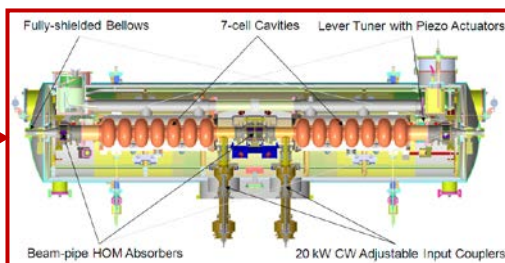
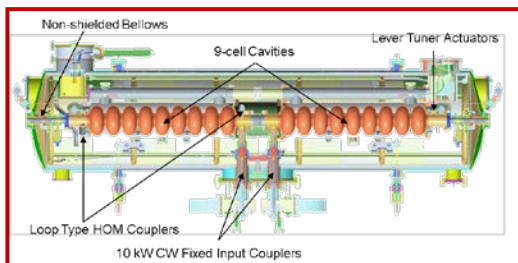
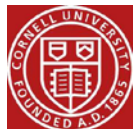

- Series of setbacks encountered
  - Strong microphonics -> detuning of cavities -> not able to operate ALICE
  - Replacement of radiation damaged shock absorbers on pumping platform, implementation of variable pump speeds to reduce resonances
  - Blockage in helium liquefier -> complete refurbishment of cryosystem (6 months)
  - Decision to swap back in original linac module to continue user runs
  - Offline alterations to module, reinstallation intended 2016

Linac cavity 2 detuning peaks at 22Hz, 70Hz, 63Hz, 139Hz, 386Hz.

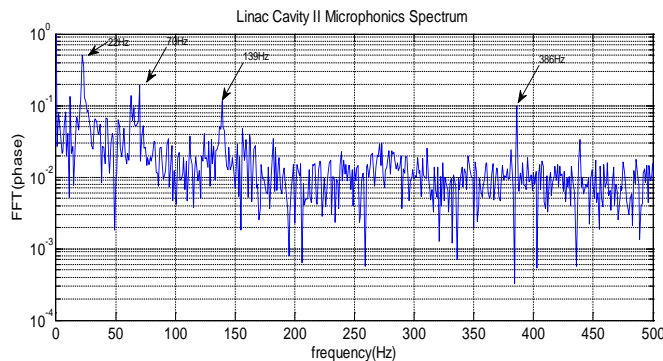



# 2013 Onwards: Stability, Feedback and DLLRF

- Stability over 2-3 hours is important for SNOM images -> DLLRF, other active feedback systems
- Master oscillator active phase correction system strongly suppresses jumps seen pre-2013
- Digital LLRF effort since 2009 - reasons for moving to digital systems are:
  - Ability to modify loop parameters during operations
  - Complex control algorithms such as adaptive feed forward to overcome beam loading effects, controlled cavity filling to limit the RF power reflection in the waveguide, Lorentz force induced detuning control, etc.
- DLLRF cards also used to diagnose and fix phase drifts and jumps found in the PI laser
- Development of AP / FEL / operational higher level software to automate processes, implement feedback e.g. on FEL wavelength

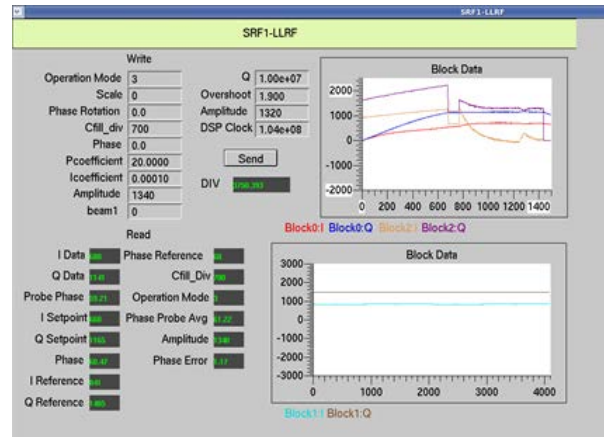
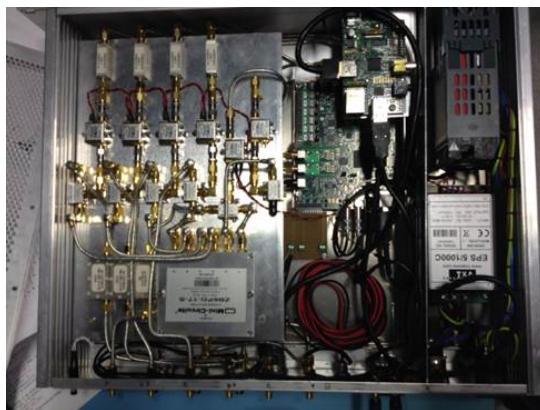
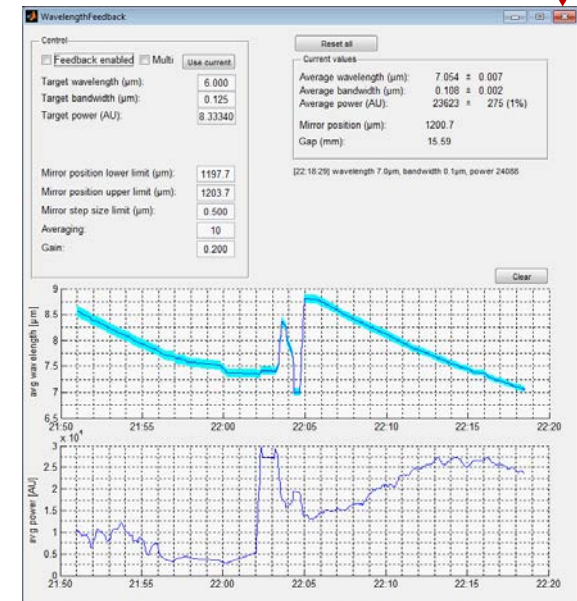
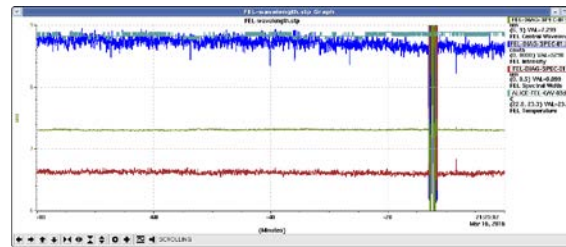
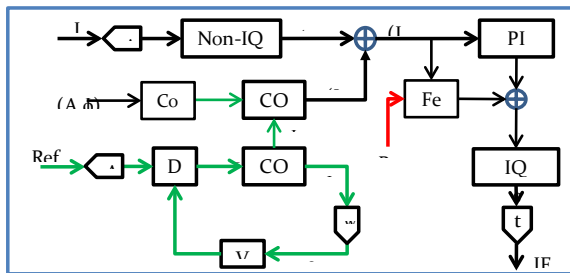

# 2014 – 2016: ALICE IR-FEL defining disease diagnosis

- Major expansion of the FELIS programme

- The different components of tissue have different IR spectra
- Towards disease diagnosis through spectrochemical imaging of tissue architecture*
- Focus is on mechanism of tissue change
- IR-FEL providing beam for 3 months of each 3 years
- ALICE has just completed it's 2015 run (May 17<sup>th</sup> 2015) – shift pattern 3 shifts / 24 hrs, Wed – Sun

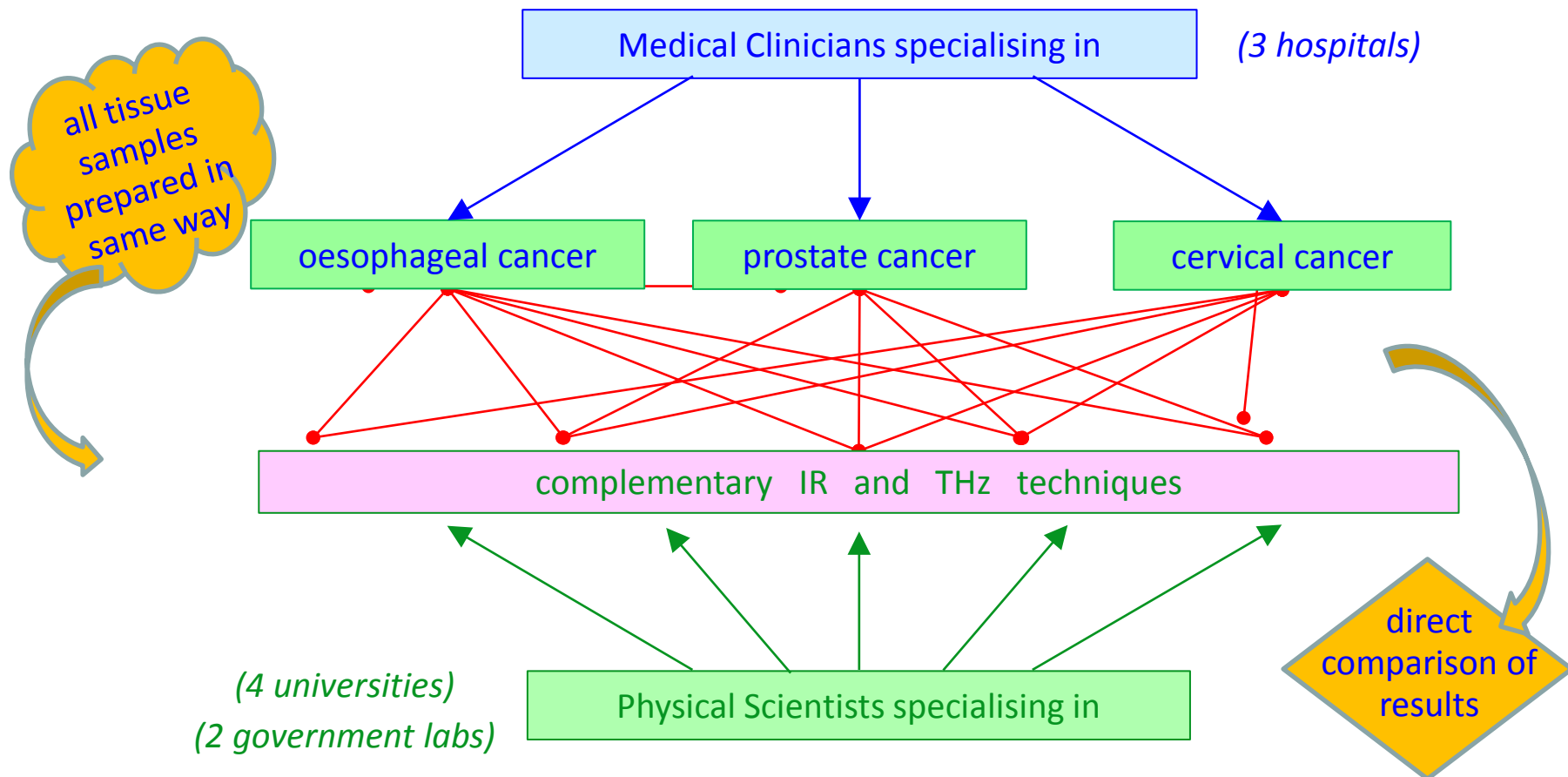

# 2014 – 2016: ALICE IR-FEL defining disease diagnosis

- Major expansion of the FELIS programme

- Example image from May shows AFM topography, SNOM transmission image (world first), calibration image for 3 wavelengths
- Image cluster analysis will be used on the ratios of the images to identify tissue components

Example 5-cluster image analysis

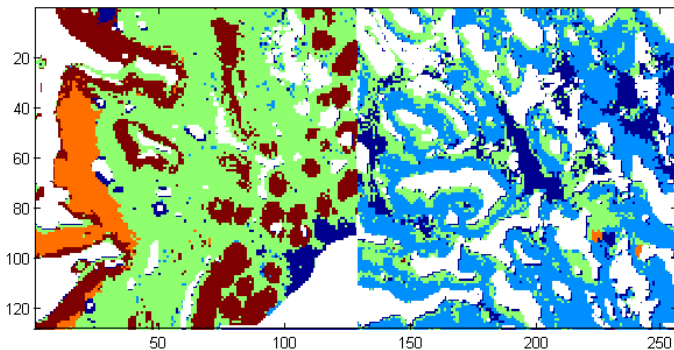

Barrett's

Cancer

each cluster corresponds to a (broad) tissue type

Blue: Stroma (cancerous sample)

Brown: Goblet Cells and Barrett's Oesophagus Tissue

Orange: Barrett's Oesophagus Nucleii

Green: Stroma (benign sample)

Cyan: Cancer

150411 Barrett's			
Filename/wavelength	FTOPO	FSNOM	FZERO
0314 – transmission o712 6.5 $\mu\text{m}$			
0315 – transmission o712 7.3 $\mu\text{m}$			
0316 – transmission o712 8.05 $\mu\text{m}$			

# Conclusion: The Evolution of ALICE

- 2000 – 2005: Conception and Birth
  - 2006: Childhood
  - 2007: That difficult teenage year
  - 2008 – 20011: Education and graduation
  - 2012 – 2015: Maturity!
  - 2016 ... Bid underway to cement ALICE as an EPSRC mid-range facility
- 
- First SCRF linac operating in the UK
  - First DC photoinjector gun in the UK
  - First ERL in Europe
  - First FEL driven by energy recovery accelerator in Europe
  - First transmission IR-SNOM imaging
- 
- ALICE was intended as a short lived test-bed and learning tool, but has transcended it's original purpose and is now a scientific facility in its own right, as well as a technology test bed – such is the utility of an ERL-FEL

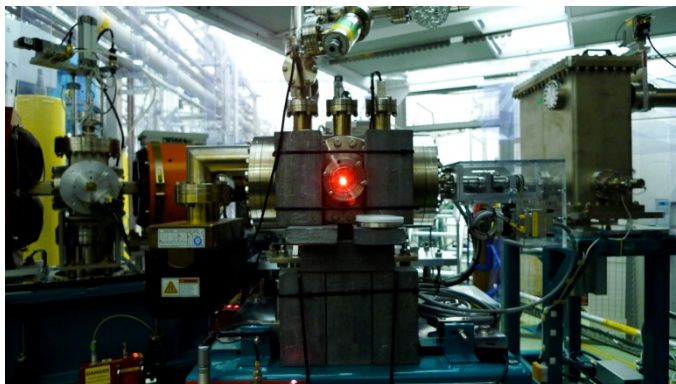

# Acknowledgements

Thanks to everyone who has contributed to making ALICE a reality – both at Daresbury and the ERL and FEL community across the world

Thanks to all those characters illustrated below who contributed material to this presentation:

*Yuri Saveliev, Mike Poole, Elaine Seddon, Deepa Angal-Kalinin, Frank Jackson, Bruno Muratori, Michelle Siggel-King, Peter Weightman, Alan Wheelhouse, Andy Moss, Neil Thompson, Dave Dunning*

