

RAL 94060

COPY 2 ~~RAL~~ R3

ACCN: 223855

**DRAL**

*Daresbury Laboratory  
Rutherford Appleton Laboratory*

**RAL Report**  
RAL-94-060

# **EU Large Facility Access Contract GE1-CT91-0034 Final Technical Report**

**A Giulietti et al**

June 1994

**Rutherford Appleton Laboratory** Chilton DIDCOT Oxfordshire OX11 0QX

**DRAL is part of the Engineering and Physical  
Sciences Research Council**

The Engineering and Physical Sciences Research Council  
does not accept any responsibility for loss or damage arising  
from the use of information contained in any of its reports or  
in any communication about its tests or investigations

**Large Facilities Pilot Programme**  
**Final Technical Report**  
**Access to the VULCAN High Power Laser Facilities**  
**at**  
**Rutherford Appleton Laboratory**  
**Contract GE1-CT91-0034, 3/12/91 - 2/12/92**  
**DRAL Report No 94060**

A Giuliotti, V Biancalana, P Chessa, D Giuliotti and L A Gizzi  
Istituto di Fisica Atomica e Molecolare, via del Giardino, 7 - 56127 Pisa, Italy

E Schifano  
Laboratoire pour L'Utilization des Lasers Intenses, Ecole Polytechnique, Palaiseau, France

T Afshar-Rad, S M Viana and O Willi  
Blackett Laboratory, Imperial College of Science, Technology and Medicine, London, UK

C N Danson, C B Edwards and W T Toner  
Central Laser Facility, Rutherford Appleton Laboratory, Chilton, Didcot, Oxon, UK

## **Summary**

The funds allocated under this contract were used to operate the VULCAN 5 Terawatt Nd:Glass laser for an experiment proposed and carried out by Dr A Giuliotti and a visiting team of young researchers from CNR Pisa, Italy, from 13th April to 23rd May 1992.

This was a major experiment for which special configurations of the laser and diagnostic equipment were required. Complex targets were required, and a special fabrication process was developed by the Target Preparation Group at RAL in order to meet the demands of the experiment.

A wide variety of laser beam outputs were provided from Vulcan including beam smoothing by random phase plates (RPP), Induced Spatial Incoherence (ISI) and Smoothing by Spectral Dispersion (SSD). This beam profiling work has been pioneered at RAL, and the Vulcan facility is uniquely equipped to support experiments requiring these advanced techniques.

A pulse sequence from the laser was used to generate a pre-formed uniform plasma using four main beams, which was then heated by a delayed interaction beam. This arrangement simulates the plasma conditions of interest to I.C.F. studies. The interaction was studied by emission spectroscopy, and optical probing using a further synchronised laser beam. Optical streak cameras were used to observe the time dependence of spatial and spectral features of the plasma emission, and Nomarski interferometry was used to diagnose plasma density distribution as a function of time during the pulse. Time resolved X-ray diagnostics gave information on the plasma temperature.

During four weeks of data taking, 180 full power shots were delivered to target (a record for a single experiment), and all the major objectives of the experiment were achieved.

A comprehensive scientific analysis is being carried out at Pisa, and will continue for several months.

All of the funding allocated to the experiment has been committed. This included laser and target area operations and diagnostics costs, support of the Italian team in the UK for a total of 36 man weeks, and visits by C Edwards and C Danson to Pisa during the organisation and analysis phases.

### **Dissemination of results**

Eight scientific papers describing the results of this work have been presented at international conferences, including the Anomalous Absorption Conference (the top international specialist meeting in this field) in the United States, the European Conference on Laser Interaction with Matter (ECLIM) in Paris, and the 4th European Quantum Electronics Conference in Florence. A paper has been published in Applied Optics. A second has been accepted to Phys. Rev. E, and a third is in preparation. Authorship of the conference and journal publications includes researchers from Imperial College and staff of the Rutherford Laboratory as well as the Pisa scientists, underlining the collaborative aspect of the work.

The results will form a central contribution to the Doctorate studies of Giulietti's graduate students.

## Journal Publications

- 1 V Biancalana, P Chessa, Handling of Quasi-Gaussian Beams by Phase Plates: Far Field Simulation, Accepted to Applied Optics (1994)
- 2 L A Gizzi, D Giulietti, T Afshar-rad, V Biancalana, P Chessa, C Danson, A Giulietti, E Schifano, S M Viana, O Willi, Production and Characterisation of Long-Scale-Length Expanding Plasmas for ICF coronal Studies, Accepted to Phys Rev E, (1994)
- 3 A Giulietti, T Afshar-rad, V Biancalana, P Chessa, C Danson, D Giulietti, L A Gizzi, E Schifano, S M Viana, O Willi, Flow Dominated Backscattering of Laser Light During Interaction with an Expanding Plasma, (in preparation)

## Laboratory Reports

- 1 T Afshar-rad, V Biancalana, P Chessa, C Danson, A Giulietti, D Giulietti, L A Gizzi, E Schifano, S M Viana, O Willi, Interaction of Smoothed or Modulated Laser Beams with long-scalelength expanding Plasmas; Rapporto Interno IFAM (Pisa 1992)
- 2 V Biancalana, P Chessa, C Danson, D Pepler, Manipulation of focal profiles using phase plates, Annual Report of Central Laser Facility, Rutherford Appleton Laboratory, 1993
- 3 A Giulietti, T Afshar-rad, V Biancalana, P Chessa, C Danson, D Giulietti, L A Gizzi, E Schifano, S M Viana, O Willi, Plasma Interaction with Smoothed or Modulated Laser Beams Diagnosed by Second Harmonic Emission and Backscattering, Annual Report of Central Laser Facility, Rutherford Appleton Laboratory, 1993
- 4 L A Gizzi, T Afshar-rad, V Biancalana, P Chessa, C Danson, A Giulietti, D Giulietti, E Schifano, S M Viana, O Willi, Production and Characterisation of Long-Scale-Length Expanding Plasmas for ICF Coronal Studies, Annual Report of Central Laser Facility, Rutherford Appleton Laboratory, 1993
- 5 L A Gizzi, T Afshar-rad, A Giulietti, D Giulietti, S M Viana, O Willi, Measurement of Electron Density Distribution in Long Scalelength Plasmas, Annual Report of Central Laser Facility, Rutherford Appleton Laboratory, 1994

- 6 T Ceccotti, S Bastiani, C Danson, A Giulietti, D Giulietti, Study of the Far-Field Intensity Distribution of a Random Phased Beam, Annual Report of Central Laser Facility, Rutherford Appleton Laboratory, 1994

### **Conference Presentations**

- 1 V Biancalana, T Afshar-rad, P Chessa, A Giulietti, D Giulietti, L A Gizzi, E Schifano, S M Viana, O Willi, Septtoscopia Risolta nel Tempo della Luce Diffusa Anelasticamente nell'Interazione Laser-Plasma, LXXVIII Congresso SIF, (Pavia 5-10 Oct 1992).
- 2 P Chessa, V Biancalana, Simulazione Numerica di Dispositivi Ottici applicati a Fasci Laser di Potenza, LXXVIII Congresso SIF, (Pavia 5-10 Oct 1992)
- 3 L A Gizzi, T Afshar-rad, V Biancalana, P Chessa, C Danson, A Giulietti, D Giulietti, E Schifano, S M Viana, O Willi, Effect of controlled Modulations on the Interaction of Smoothed and Unsmoothed Laser Beams with Coronal Plasmas, 22nd Annual Anomalous Absorption Conference, Lake Placid,, New York
- 4 L A Gizzi, T Afshar-rad, V Biancalana, P Chessa, C Danson, A Giulietti, D Giulietti, E Schifano, S M Viana, O Willi, Production and Characterisation of Long Scale Length Expanding Plasmas for ICR Coronal Studies, 22nd ECLIM (Paris, May 1993)
- 5 A Giulietti, T Afshar-rad, V Biancalana, P Chessa, C Danson, D Giulietti, L A Gizzi, E Schifano, S M Viana, O Willi, Interaction of Smoothed or Modulated Laser Beams with Long-Scale-Length Expanding Plasmas, 22nd ECLIM (Paris, May 1993)
- 6 V Biancalana, P Chessa, C N Danson, A Giulietti, D Pepler, Smoothing and Manipulation of High Power Laser Beams, 4th European Quantum Electronics Conference, Florence, Sept 1993
- 7 V Biancalana and P Chessa, Far-field intensity profiles of smoothed beams evaluated by FFT, Euroconference on the Generation and Application of Ultrashort X-ray Pulses, Salamanca, Spain, March 1994.
- 8 A Giulietti et al, Laser Interaction with Coronal Plasmas, Euroconference on the Generation and Application of Ultrashort X-ray Pulses, Salamanca, Spain, March 1994.



Dr A Guilietti, his experimental group of researchers from Pisa & RAL Support Staff during his CEC funded experiment on VULCAN.





# Interaction of Smoothed & Modulated Laser Beams with Long Scalelength Expanding Plasmas.

## Introduction

"Direct-drive" Inertial Confinement Fusion (ICF) depends on the efficient, uniform coupling of laser energy to the target fuel. The role of spatial and temporal profile, and coherence effects of the laser beam is a key issue in the study of the physics of this interaction.

When a high power laser beam is incident on a solid target, density and temperature profiles are established during the early part of the pulse. Densities range from solid at the target surface, through to a low density plasma corona. These profiles are established by the ablation of material from the cold solid into a hot, low density ( $10^{-3}$  g.cm<sup>-3</sup>) region. Modulations on the spatial and temporal profile of the laser leads to non-linear hydrodynamic instabilities which affect the coupling of laser energy into the low density plasma. Such modulations can grow from noise in a coherent beam via the filamentation instability<sup>1,2</sup>. The modulations affect the propagation of the laser, providing positive feedback which enhances the growth of the laser beam inhomogeneities.

To investigate the effects of beam uniformity on energy transport in the plasma requires the generation of long scalelength plasmas to simulate ICF coronas, and the ability to control the beam coherence and focal spot intensity distribution. Recent experiments<sup>3,4</sup> have used a line focus geometry to pre-form homogeneous plasmas with negligible motion along the interaction axis. These experiments indicate that filamentation effects<sup>5</sup> can be suppressed or eliminated using beam smoothing techniques.

## Objectives

- The study of fundamental energy coupling processes
- Production of a plasma with a longitudinal scalelength of interest for ICF studies
- Characterisation of the plasma using interferometry and X-ray spectroscopy
- Testing of advanced beam smoothing techniques
- To induce preferential growth of filamentation by modulation of the interaction beam
- To diagnose gradients in the interaction region<sup>2,6</sup> using second harmonic emission
- To study stimulated Brillouin back-scattering

## Experimental method

The experimental set-up is shown in the layout of Fig 1(a). Two pairs of opposite beams of the Vulcan system operating at 1.053 micron were focused using  $f/10$  optics, and superimposed on the same 600 micron spot on the target plane. The four synchronised 600 ps laser pulses provided an irradiance on target of typically  $6 \cdot 10^{13} \text{ W.cm}^{-2}$ . In most of the shots aluminium dot targets coated on 0.1 micron Formvar stripes were used (Fig 1(b)). Dots were 400 micron in diameter in order to be uniformly irradiated in the centre of the 600 micron diameter laser spot to have underdense plasmas at the time of interaction. Targets of different thicknesses, shapes and materials (eg. bismuth) were also used. The interaction beam was incident along the symmetry axis of the four heating beams and the target was focused with  $f/15$  optics. Two oscillators were available for use with the interaction beam, narrow-band ( $0.5 \text{ \AA}$ ) and broad-band ( $13 \text{ \AA}$ ).

The focal spot produced by the laser was modified by the use of random phase plates. Induced Spatial Incoherence (ISI) and Smoothing by Spectral Dispersion (SSD) techniques were employed to smooth temporally the coherence effects of the beam. The interaction pulse was delayed by typically 2.5 ns with respect to the heating pulses, allowing the plasma to expand. A sixth 100 ps beam was frequency doubled, delayed and used as a probe. An X-ray streak camera was used in conjunction with a TIAP crystal to obtain time resolved X-ray spectra from which plasma electron temperatures could be measured as a function of time.

Two second harmonic detection channels were employed. The forward channel was equipped with an optical streak camera and spectrometer and gave alternately time resolved images and spectra. The sideward channel was equipped with an optical streak camera coupled to a spectrometer for time resolved spectroscopy and an optical 120 ps gated image intensifier to record images. A further infrared detection channel was commissioned to investigate stimulated Brillouin back-scattering. It was equipped with an IR spectrometer and a streak camera, giving time-resolved spectra about the fundamental laser frequency.

## Characterisation of the plasma before and after interaction

One of the purposes of the experiment was to produce and accurately characterise a test plasma for ICF-like interaction studies. A preliminary design of the experiment was done on the bases of a self similar model of plasma expansion from laser irradiated foil targets<sup>7</sup>. The density profile predicted by this model for a  $0.5 \text{ \mu m}$  aluminium foil heated at  $6 \times 10^{13} \text{ W.cm}^{-2}$ , 3ns after heating, gives a maximum of  $1.3 \times 10^{20} \text{ cm}^{-3}$ . The corresponding density scale length is about 1mm, suggesting that the initial 1-D expansion suffers a moderate 2-D distortion at this stage. The expected electron temperature is slightly higher than 1 KeV.

A number of interferograms were obtained with the green probe beam crossing the plasma perpendicularly to the plane where heating and interaction beams were located. Fig 2. shows the fringe patterns produced by the plasma 3ns after heating without interaction. Abel inversion of the fringe pattern shows a longitudinal scalelength of the order of 1mm and a radial scale length definitely higher than the focal spot of the interaction beam. At 220 $\mu$ m from the original target surface the measured electron density is  $8 \times 10^{19} \text{cm}^{-3}$ , lower than expected from the model, possibly due to the partial 2-D expansion. Interferograms obtained after interaction clearly show the density perturbation produced by the interaction beam and the signature of its structures.

The temporal behaviour of plasma electron temperature  $T_e$  was monitored using time-resolved X-ray spectroscopy of K-shell A1 emission<sup>8</sup>. An X-ray streak camera coupled to a crystal (TIAP) X-ray spectrometer was set to record time-resolved spectra of X-ray emission from the plasma of the range between 1.7 and 2.3 KeV. Fig 3(a) shows a typical spectrum where the effect of both heating and interaction beams is clearly visible. The interaction beam was delayed by 2.5 ns.

Intensity ratios between Hydrogenic and He-like lines were measured as a function of time. These ratios were compared with predictions from the atomic physics numerical code RATION<sup>9</sup>. The electron temperature as a function of time resulting from this spectrum is shown in Fig 3(b).

### **Simulation and observation of focal spots produced with smoothed & modulated beams**

Phase plates are powerful tools to modify the intensity pattern of a laser beam in the far field region. We developed a code to simulate the effect of phase devices on real beams<sup>10</sup>. The code uses FFT routines to evaluate the Fresnel integral in paraxial approximation. An arbitrary input field distribution can be assigned. Real beams are simulated with quasi-Gaussian beams obtained by adding a suitable smooth random function to the phase of Gaussian beams. Another discrete (e.g. binary) function can be added to the phase to simulate either random or regular phase plates.

In particular, we considered phase devices to split the far-field distribution into several spots. This is achievable using stripe phase plates having a non- $\pi$  dephasing between the odd and even stripes. Simulation and experimental results are shown in Fig 4 in the case of triple spot. Fig 4(a) shows a graphical output of our simulation code for a 1.053 micron wavelength laser beam with the typical focusability of Vulcan beams. The beam propagates through a 6mm-stripe phase plate with  $\Phi = \pi/2$  dephasing, and is focused by an  $f=150\text{cm}$  lens. Fig 4(b) shows an experimental equivalent plane image obtained with a 6mm-stripe phase plate with  $\Phi=\pi/2$ , focused by a 10m focal length and demagnified to be comparable to the focusing condition of Fig 4( a).

The probe channel enabled time integrated images to be taken of the plasma in side emitted second harmonic light. Fig 4(c) shows one of these images obtained with the same 6mm-stripe phase plate on the interaction beam. Although enhancement of the contrast of the structures may be due to the non-linear production of the second harmonic, the three spot pattern is clearly visible. Circular random phase plates have been used in the experiment, and compared with simulations. Using  $\pi$  de-phasing coatings the usual RPP far field distribution was reproduced in the focal spot, namely an average smoothing with high contrast small scale speckle pattern. With our  $f=150\text{cm}$  focusing lens, the speckle size was large enough to seed filamentation resulting in an increase of second harmonic emission. The effects of a non- $\pi$  RPP have been also analysed and tested experimentally. Such a plate produces a particular far-field pattern, given by an incoherent superposition of the usual RPP pattern with a bright image of the unperturbed focal spot. This configuration was used to investigate whole beam self-focusing in the plasma.

### **Second harmonic and SBS time-resolved spectroscopy**

Many time-resolved spectra have been obtained in different experimental conditions and their analysis is presently in progress. Time resolved spectra of the forward emitted second harmonic were taken with a 1/2m spectrometer coupled to an S20 streak camera. Fig 5 shows a typical time resolved spectrum of the second harmonic emitted in the forward direction under standard experimental conditions. A 500nm Al dot target was heated at  $6 \times 10^{13}\text{W.cm}^{-2}$ . The interaction beam was unsmoothed with a focal spot of 120 microns, delayed by 2.5ns respect to the heating beams. The interaction irradiance was  $2.8 \times 10^{14}\text{W.cm}^{-2}$ . The narrow spectral line appearing before the interaction signal is a wavelength fiducial. The second harmonic light emitted forward in this condition is spectrally rather narrow and slightly red-shifted. Occasionally a temporally modulated emission was observed while the interaction pulse was temporally smooth. In few temporally-modulated shots (resulting from double mode lasing) the forward spectrum resulted strongly modulated time with a larger band-width and a higher intensity. We observed an increase in second harmonic intensity also when a RPP was put on the interaction beam. This is consistent with our estimate that the size of the speckle features could seed the filamentation instability.

In Fig 6 we show the time resolved spectrum of the second harmonic emitted sideward in the same shot of the spectrum reported in Fig 5. The side-emitted second harmonic was also analysed with a 1/2m spectrometer coupled with an optical streak camera. Both the spectral and the temporal features showed poor shot-to-shot reproducibility. All the spectra show features with a  $2\text{\AA}$  to  $5\text{\AA}$  band-width, red-shifted by typically  $3\text{\AA}$  with respect to the exact second harmonic. The red-shift was nearly reproducible shot by shot, but in some shots it was either increasing or decreasing with time. In the presence of a temporally modulated interaction beam the spectrum was strongly modulated in time and spectrally

broadened ( $\Delta\lambda > 10\text{\AA}$ ). The spectra were often temporally modulated even with a temporally smooth interaction pulse. These modulations were not reproducible shot by shot and were observed when high Z targets were used. Overall, the intensity of the spectral features seems to be rather insensitive to target material, RPP-smoothing and focusing condition of the interaction beam.

The SBS spectra were collected with a 1m spectrometer coupled to an S1 streak camera. These results were more reproducible than the second harmonic data. A typical SBS spectrum obtained in standard experimental condition is reported in Fig 7. Two temporally separated phases with different spectral behaviour can be seen in these spectra. At the beginning of the interaction a bright short flash is emitted in broad spectrum, extended some tens of  $\text{\AA}$  both in blue and red direction with respect to the laser wavelength. A second emission follows in time with completely different spectral properties. It is a narrow-band emission which slowly shifts from the red side to the blue side of the unperturbed wavelength. This later emission was missing when a broad-band interaction beam was used with ISI and SSD smoothing techniques. The first emission is unusually broad and possibly related to both flow velocity of the plasma and strong non-linear phenomena which saturate soon at the beginning of the pulse.

We are presently investigating the correlation between the second feature of the spectrum (overall band-width, rate of shifting) and the interaction condition (laser intensity, plasma density and temperature).

## Conclusion

The experiment was extremely successful, and all the major objectives were achieved. Some two hundred laser shots were successfully fired on target. An extensive data set was collected, and the detailed interpretation phase is continuing. Preliminary analysis shows that the experiment will make a significant impact in the control of some crucial processes in laser fusion, and improve the understanding of basic plasma physics issues.

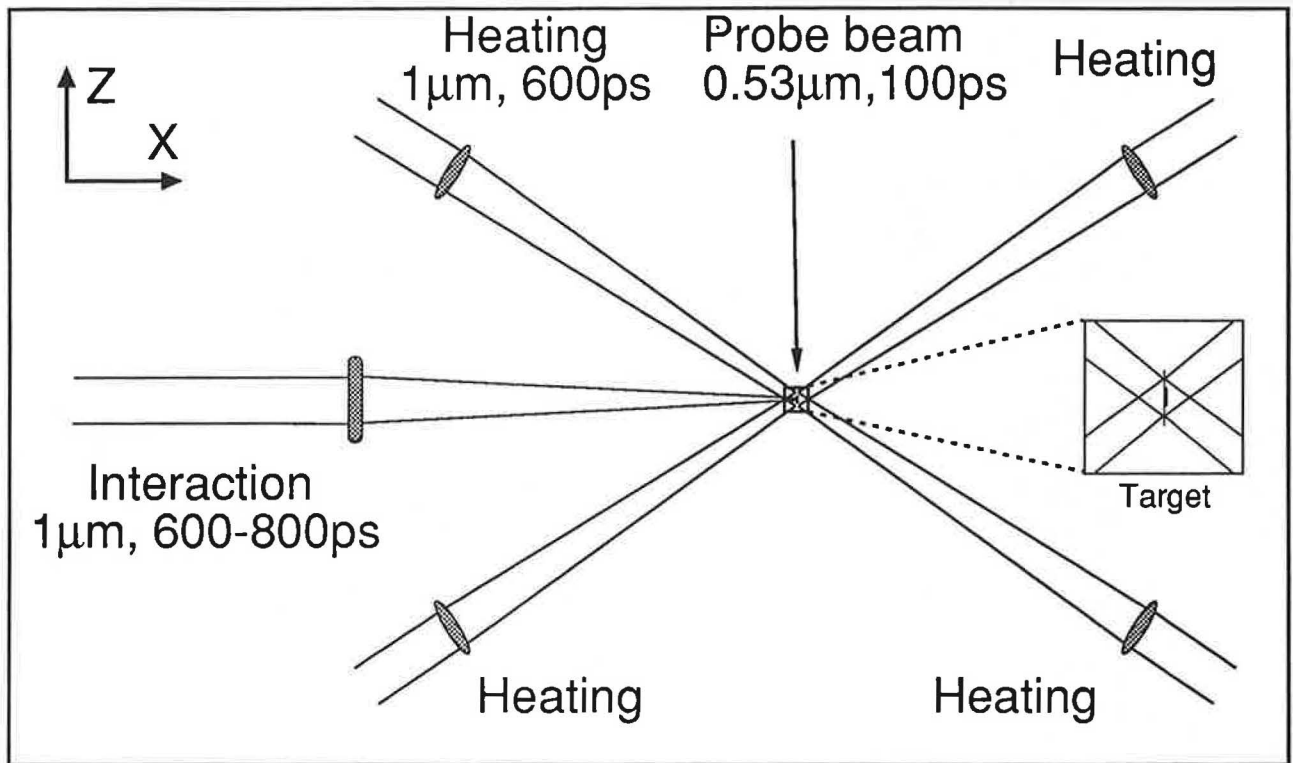
## References

- 1 WL Kruer, "The physics of Laser-Plasma Interactions" (Addison-Wesley, New York, 1988)
- 2 V Biancalana, M Borghesi, P Chessa, I Deha, A Giulietti, D Giulietti, LA Gizzi, O Willi, *Europhys Lett.*, **22**, 175 (1993)
- 3 D Basset, N Islava, O Willi, A Giulietti, CLF Annual Report, 1987 p.53
- 4 M Desselberger, M Dunne, FY Khattak, D Riley, O Willi, CLF Annual Report, 1992 p.35
- 5 O Willi, T Afshar-Rad, S Coe, A Giulietti, *Phys. Fluids* **B2**, 1318 (1990)

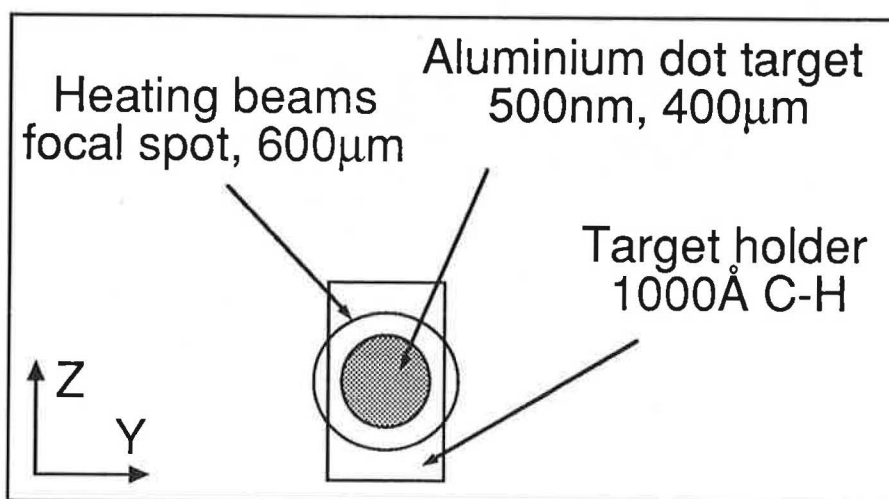
- 6 D Giulietti, GP Banfi, I Deha, A Giulietti, M Lucchesi, L Nocera, ZZ Chen, *Laser & Particle Beams*, **6**, 141 (1988)
- 7 RA London, MD Rosen, *Phys. Fluids* **29**, 3813 (1986)
- 8 L A Gizzi, D Giulietti, T Afshar-Rad, V Biancalana, P Chessa, C Danson, A Giulietti, E Schifano, S M Viana, O Willi, Production and Characterisation of Long Scale-Length Expanding Plasmas for ICF Coronal Studies, Submitted to *Phys. Rev. E* (1993)
- 9 RW Lee et al., *J. Quant. Spectrosc. Radiat. Transfer* **32**, 91 (1984)
- 10 V Biancalana, P Chessa, Accepted for publication in *Applied Optics* (1993)

### **Acknowledgement**

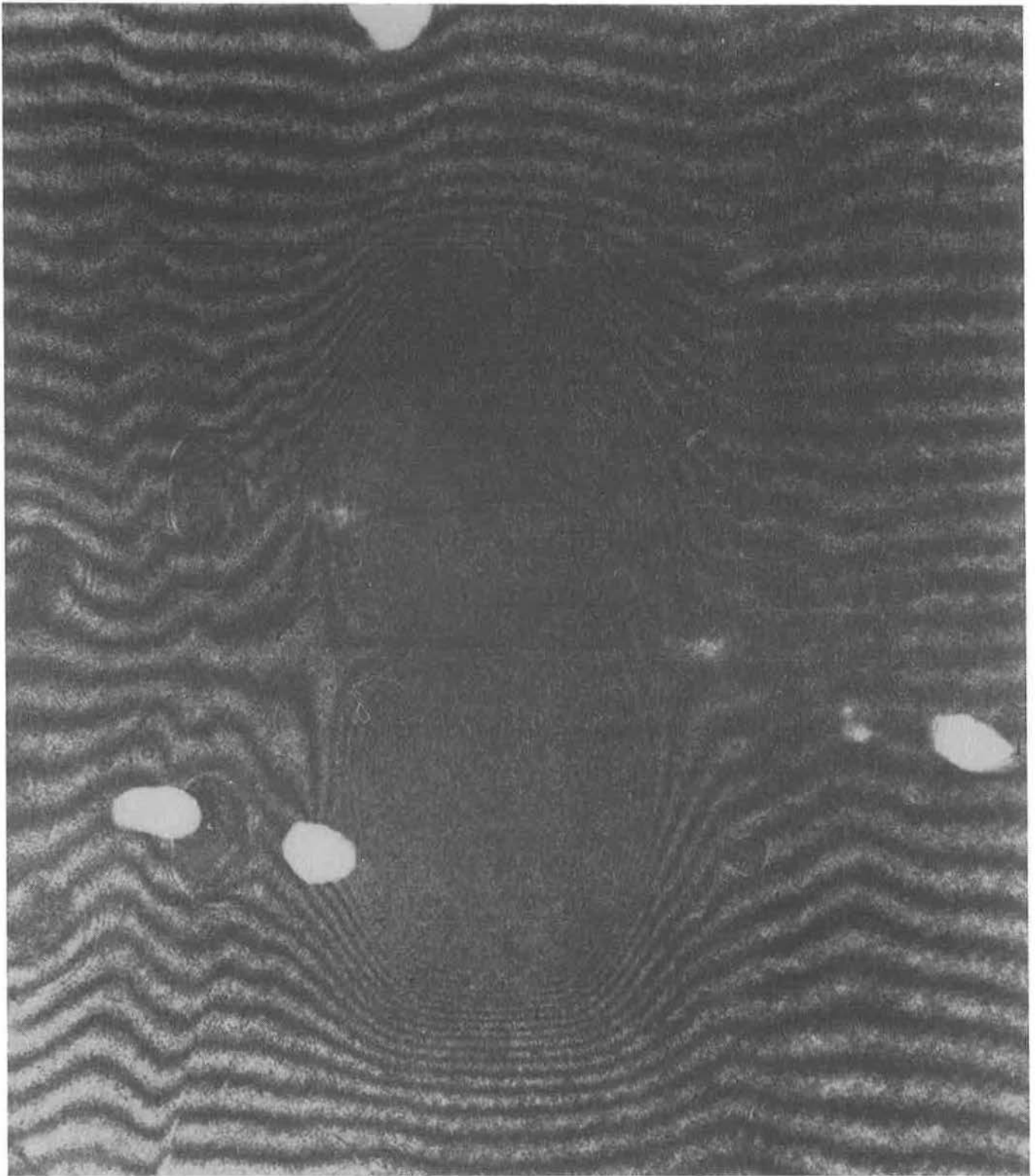
This work was funded by an EC grant. The authors would like to thank the staff of the Central Laser Facility at the Rutherford Laboratory for their invaluable and enthusiastic support.



**Fig.1(a) Schematic of the experimental arrangement**

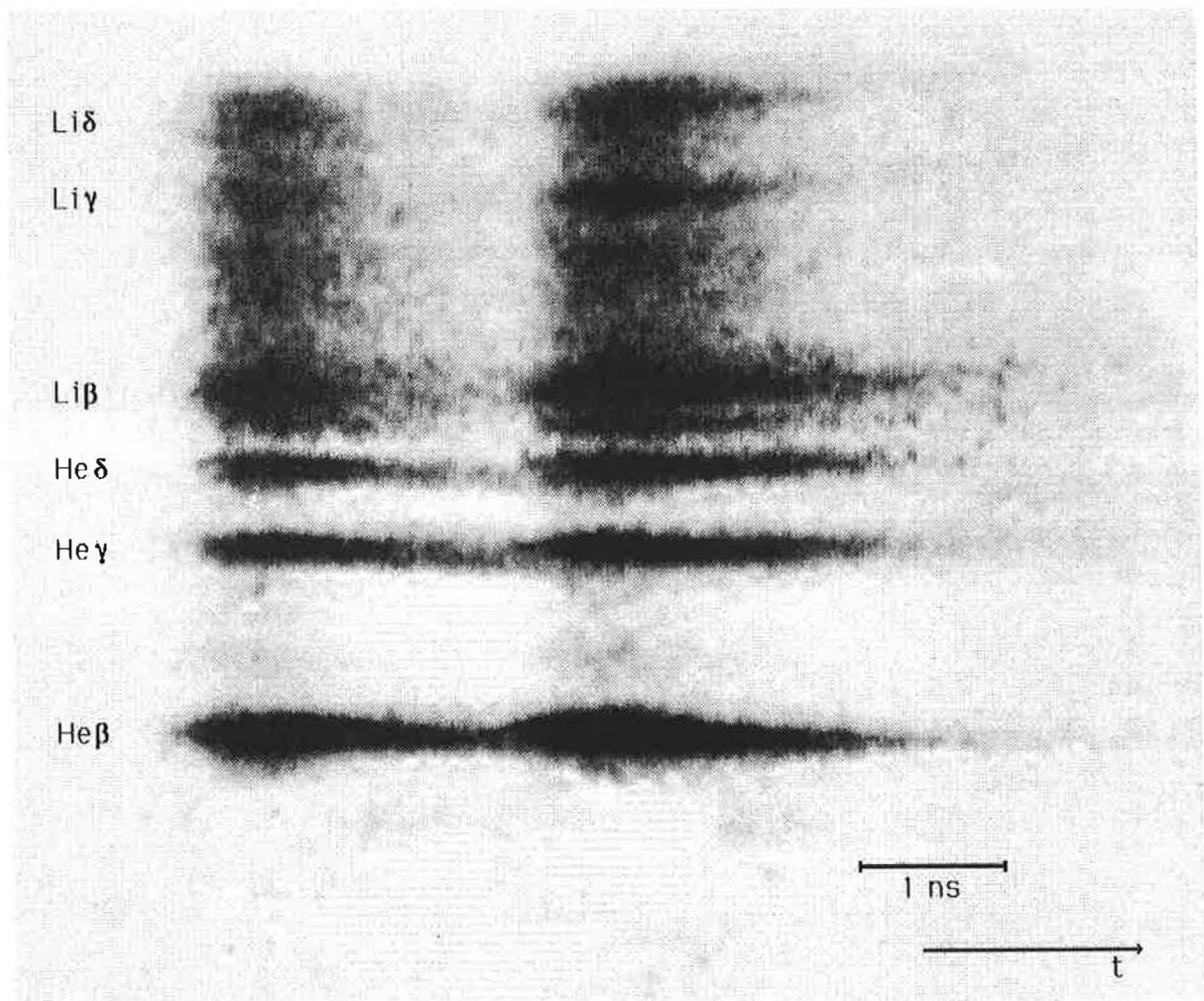


**Fig.1(b) Schematic of the dot targets used for the experiment**

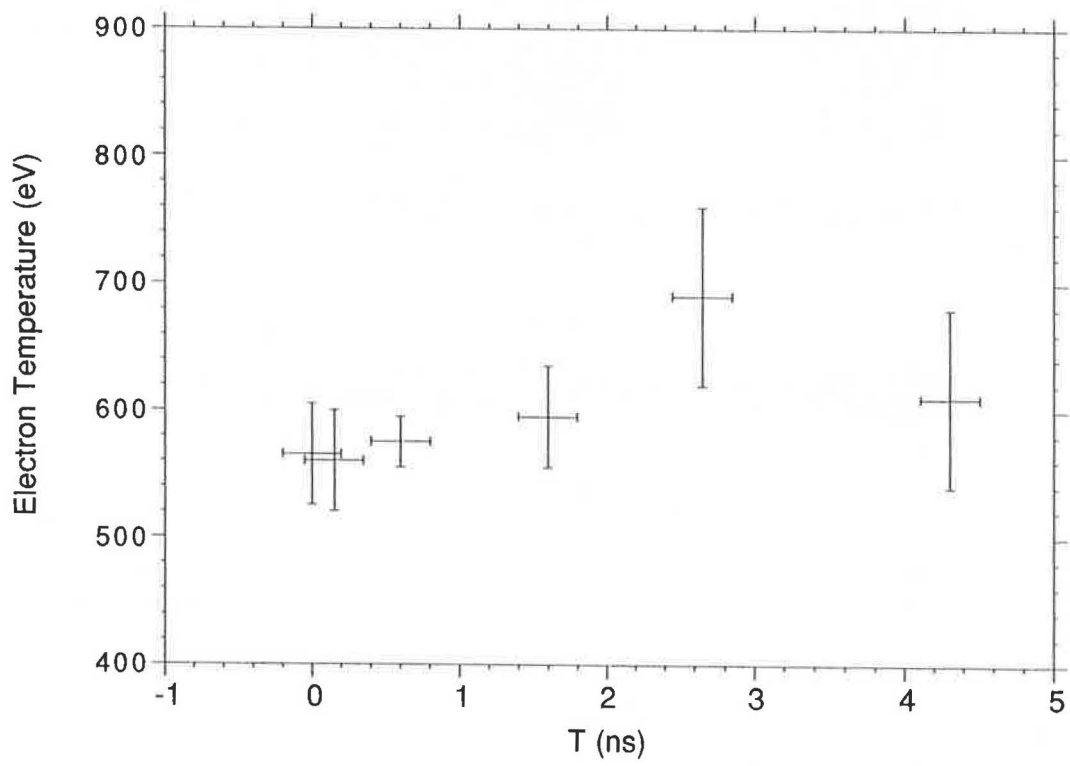


**Fig.2 Interferogram of the expanding plasma without the interaction beam**

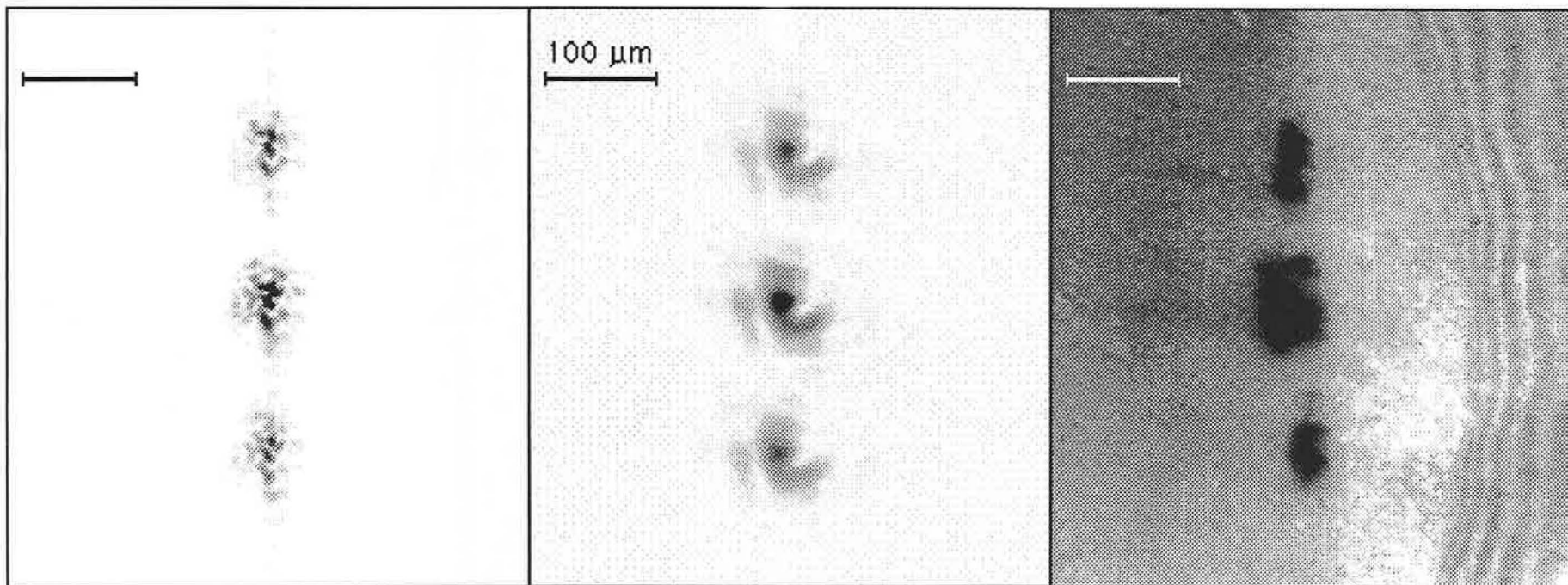




**Fig.3(a)** Time resolved X-ray spectrum of the plasma (interaction beam delayed by 2.5 ns)



**Fig.3(b) Plasma electron temperature variation with time**

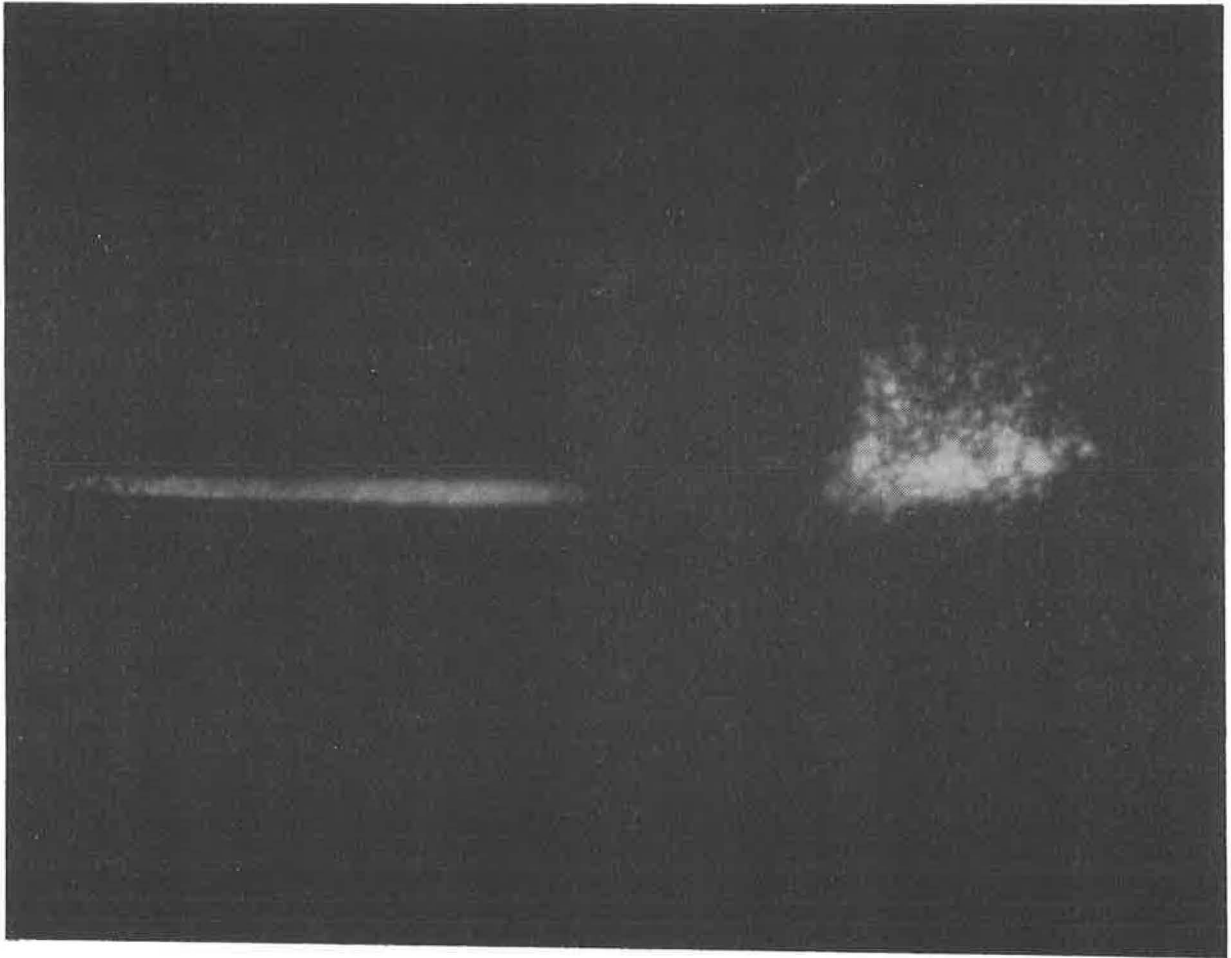


**Fig.4 Triple spot production using a random phase plate**

**a) Simulation**

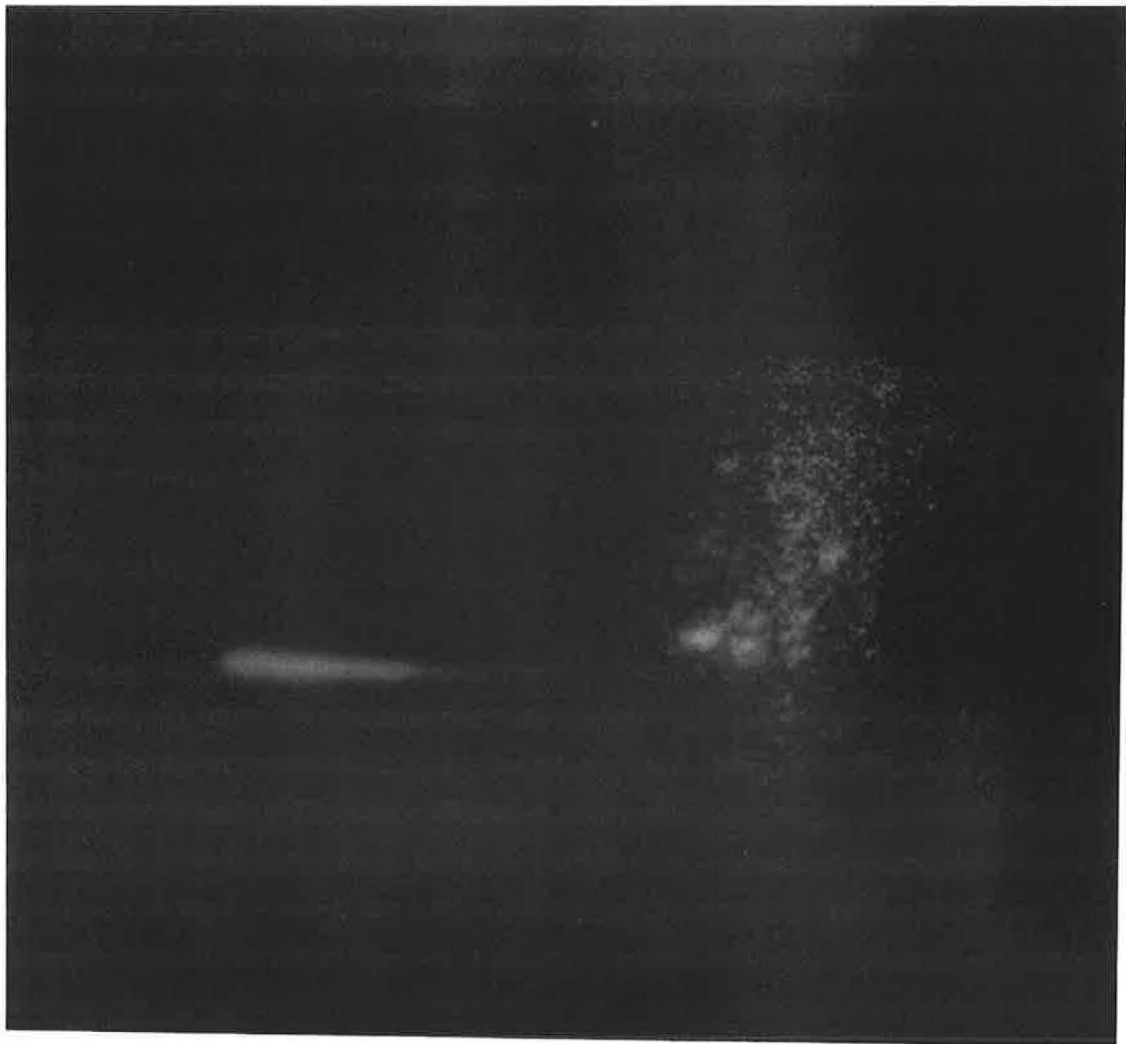
**b) Experimental**

**c) Second harmonic emission**

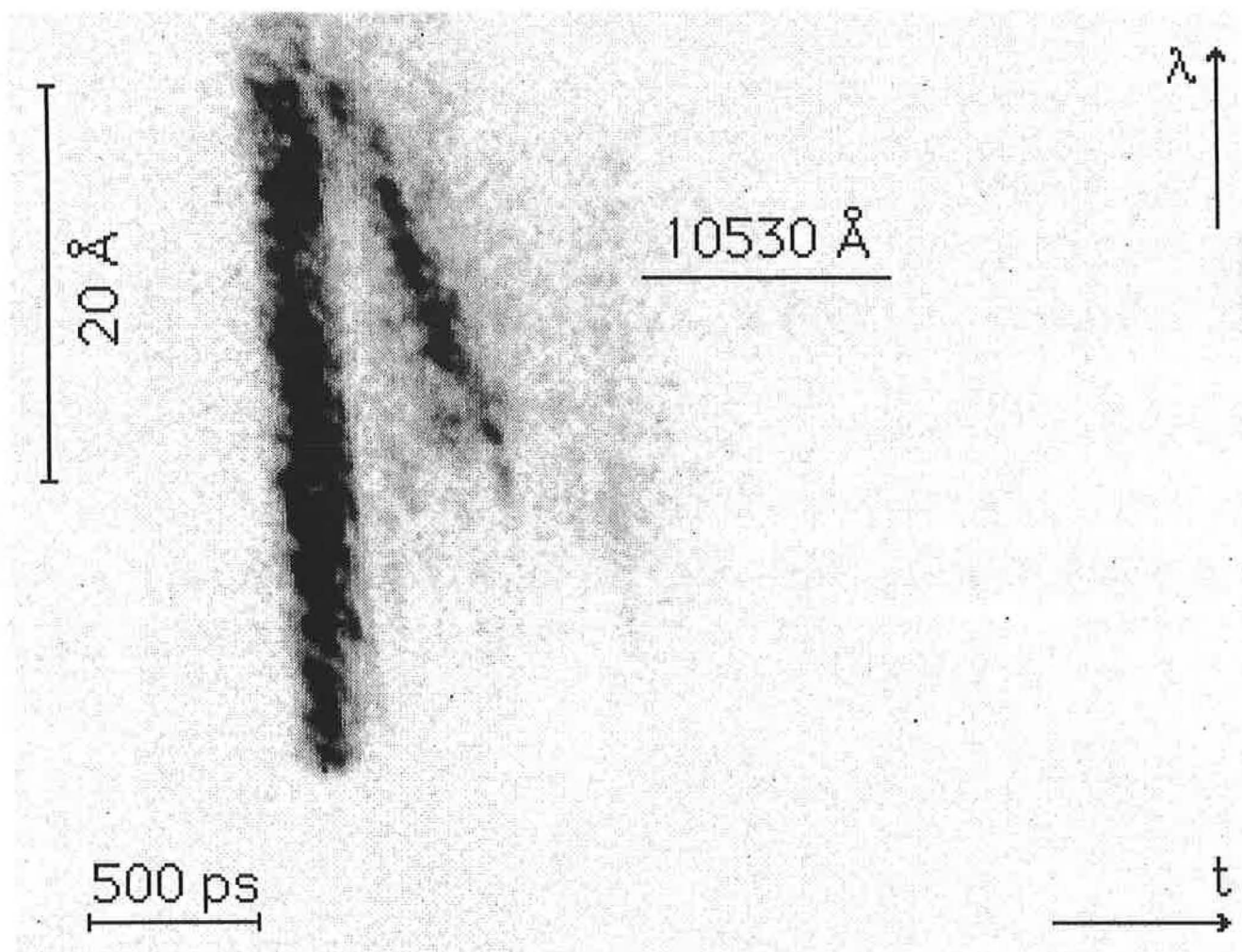


**Fig.5 Time resolved spectrum of forward emitted second harmonic**

(The feature on the left of the spectrum is the exact 2nd harmonic fiducial)



**Fig.6 Time resolved spectrum of side emitted second harmonic**  
(The feature on the left of the spectrum is the exact 2nd harmonic fiducial)



**Fig.7 Time resolved SRS spectrum**

**Interaction beam intensity  $7.10^{13} \text{ W.cm}^{-2}$**

**(The horizontal line shows the laser wavelength spectral position)**



